

F · S · T[®]

FINE SCIENCE TOOLS



FINE SURGICAL INSTRUMENTS FOR RESEARCH[™]

FINE SCIENCE TOOLS

CATALOG 2020

Letter from the Chairman of the Board

Dear customers,

After many years at the head of FST, it's time for me to start my well-earned retirement. Beforehand, I would like to personally thank you for your loyalty over the past 40 years. From the day Fine Science Tools was founded, we have always worked hard to provide our customers with the highest quality instruments and outstanding customer service, which you deserve. Thanks to our loyal, supportive customers we are still the leading global supplier for universities, research organizations and scientific institutions for surgical and microsurgical instruments made in Europe. As a result of this sustained success and continuous growth, our US office moved into a larger facility, making it possible to provide even better customer service and support.

This expansion is cohesive with our motto for this year: "VISION 2020". In relation to this motto, there has also been a change in management. Leading into my retirement, I am very happy that I have arranged for my nephew, Markus, to become the new owner and director of FST. He will work together with my son Rob, who is currently the President and owner of FST for many years now.

Markus has many years' of experience as a manager for various large companies. Before joining FST, he was a manager responsible for several marketing and sales agencies. With his expertise, he will actively support Rob, Michael and Christina in the management of FST, making sure that our name continues to be synonymous with outstanding quality and service. He will effectively apply his knowledge and experience to help the company break into new and growing markets around the world.

Now, I would like to take this opportunity to thank you once again, on behalf of myself and the Fine Science Tools team, for your continued support and loyalty. We look forward to working with you and supporting you with your projects and undertakings in the future.

Sincerely,



Hans Gawenda,
Chairman of the Board



Hans Gawenda
Chairman of the Board



Markus Gawenda
Managing Partner



Rob Gawenda
President



Michael Dosch
Chief Executive Officer



Scissors	3 – 35
Spring	3 – 14
Fine	15 – 28
Surgical	29 – 35
Bone Instruments	36 – 49
Rongeurs	36 – 39
Cutters	40 – 47
Other Bone Instruments	47 – 48
Curettes & Chisels	49
Scalpels & Knives	50 – 61



Forceps	63 – 91
Dumont	63 – 72
Fine	73 – 80
Moria	74
S&T	75, 77
Standard	81 – 91
Hemostats	92 – 97



Probes & Hooks	99 – 103
Spatulae	102 – 105
Pins & Holders	106 – 107
Spoons	108
Wound Closure	110 – 121
Needle Holders & Suture	110 – 118
Staplers, Clips & Applicators	119 – 121
Retractors	122 – 129
Vascular Instruments	130 – 139
Clamps & Occluders	130 – 134
Ligation Aids	135
Dilation & Cannulation	136 – 139



Animal Accessories	141 – 143
Feeding Needles	141
Animal Identification	142 – 143
Instrument Care & Accessories	144 – 155
Hot Bead Sterilizer	149
Instrument Cases	152 – 155
Surgical Accessories	156 – 159
Drill Accessories	157
Cauterizers	158
Laboratory Accessories	160 – 171
Tools	160 – 165
Magnifiers & Lens Paper	166 – 171



Student Quality Instruments	173 – 179
Quality instruments with the student in mind	
Scissors	173 – 174
Vessel Dilator	175
Forceps	175 – 177
Hemostat, Needle Holder, Pin Holder, Scalpel Handle & Retractor	178 – 179



Reference Pages	181 – 200
Worldwide Locations	181
Scissors Test	182
Features and Alloys	183
Maintenance and Care	184 – 185
Quality Control	186
Student Line	187
Selection	188
Dumont	189
Numerical and Alphabetical Indexes	190 – 199
Additional Information	200



Scissors, Bone Instruments & Scalpels

Spring Scissors	Pages	3 – 14
Fine Scissors	Pages	15 – 28
Surgical Scissors	Pages	29 – 35
Bone Instruments	Pages	36 – 49
Scalpels & Knives	Pages	50 – 61



These Vannas-style spring scissors have the smallest blades ever produced. They are ideal where space is restricted and where absolute precision is demanded.



200%

Cutting edge: 2 mm
Tip diameter: 0.05 mm
8 cm



Straight

No. 15000-03



Curved

No. 15000-04

The short taper is ideal for small, precise cuts.



250%

Cutting edge: 2.5 mm
Tip diameter: 0.05 mm
8 cm



Straight

No. 15000-08



Curved

No. 15001-08



Angled to side

No. 15002-08

MOST POPULAR

The long taper is ideal for cutting vessel walls or when a longer cutting edge is needed.



300%

Cutting edge: 3 mm
Tip diameter: 0.05 mm
8 cm



Straight

No. 15000-00



Curved

No. 15000-10

MOST POPULAR

Vannas



Cutting edge: 4 mm
Tip diameter: 0.15 mm
10.5 cm



Straight

No. 15018-10



Curved

No. 15019-10

Vannas-Tübingen



Cutting edge: 5 mm
Tip diameter: 0.1 mm



Straight
8.5 cm

No. 15003-08



Curved
8.5 cm

No. 15004-08



Angled to side
8.5 cm

No. 15008-08

**MOST
POPULAR**



Angled up
9.5 cm

No. 15005-08

Vannas Scissors with
Microserrations

Microserrated to minimize slippage.

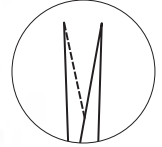

Tip diameter: 0.1 mm



Straight

Cutting edge: 4 mm
8.5 cm
No. 15070-08



Curved

Cutting edge: 4 mm
8.5 cm
No. 15071-08

Cutting edge: 5 mm
9 cm
No. 15007-08

Miniature Vannas

Hand finished using 40x magnification, these tips are especially useful when incising vessel walls for catheter insertion.



Cutting edge: 5 mm
Tip diameter: 0.1 mm
8 cm



Straight

Moria 9600
No. 15396-00



Curved

Moria 9601
No. 15396-01

Titanium Vannas



For more information see page 183.

Cutting edge: 5 mm
Tip diameter: 0.3 mm
9.5 cm



Straight

No. 15610-08



Curved

No. 15615-08



Angled up

No. 15617-08



Straight

Sharp/Sharp
No. 15000-02



Curved

Sharp/Sharp
No. 15000-01

Blunt/Blunt
No. 15000-12

Blunt/Blunt
No. 15000-11

Cutting edge: 6 mm
Tip diameter: 0.1 mm
5.7 cm



Cohan-Vannas

Long cutting blades for a more controlled cut.

ToughCut® Spring Scissors



For more information
see page 183.

Cutting edge: 6 mm
Tip diameter: 0.3 mm
12.5 cm

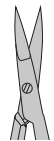

Straight

No. 15124-12



Curved

No. 15123-12

Round Handled Vannas

Round handles allow easy fingertip adjustments.



Cutting edge: 6 mm
Tip diameter: 0.075 mm
12.5 cm



Straight

No. 15400-12



Curved

No. 15401-12

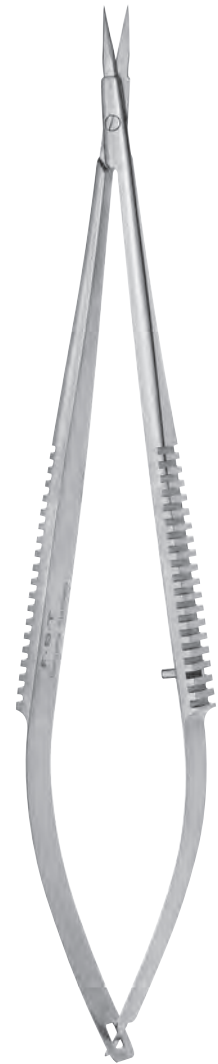

Cutting edge: 6 mm
Tip diameter: 0.15 mm
14 cm



Straight

No. 15020-15

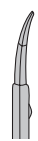

Curved

No. 15021-15

Ceramic Coated Spring Scissors



Cutting edge: 7 mm
Tip diameter: 0.1 mm
10 cm

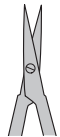

Straight

No. 15750-11



Curved

No. 15751-11

Vannas-Wolff



Cutting edge: 7 mm
Tip diameter: 0.15 mm
10 cm



Straight

Moria MC52
No. 15370-52



Curved

Moria MC50
No. 15370-50

Ultra long cutting edge
without sacrificing tip width.



Cutting edge: 8 mm
Tip diameter: 0.1 mm
8.5 cm



Straight

No. 15009-08

SCISSORS

Same as No. 15006-09 but with a ball tip to prevent piercing of underlying tissue.



Cutting edge: 10 mm
Tip diameter: 0.125 mm
10 cm



Angled

No. 15006-09



Cutting edge: 8 mm
Tip diameter: 1.3 mm Ball
9 cm



Angled

No. 15033-09



Cutting edge: 8 mm
Tip diameter: 0.15 mm
10 cm



Straight
Sharp/Sharp

No. 15024-10



Straight
Blunt/Blunt

No. 15025-10



Curved
Sharp/Sharp

No. 15023-10

Dowell



Cutting edge: 10 mm
Tip diameter: 0.1 mm
11.5 cm



Straight

No. 15040-11

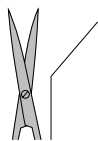

Angled up

No. 15042-11

Noyes



Cutting edge: 14 mm
Tip diameter: 0.2 mm
12 cm



Straight

No. 15012-12



Curved

No. 15011-12

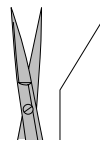

Angled up

No. 15013-12

Tungsten Carbide Noyes

Tungsten carbide cutting edges provide long lasting sharpness.



**TUNGSTEN
CARBIDE**

For more information
see page 183.

Tungsten Carbide Cutting Edges

Cutting edge: 14 mm
Tip diameter: 0.275 mm
12 cm



Straight

No. 15514-12

Castroviejo

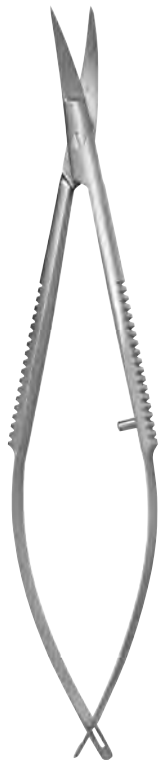

Cutting edge: 10 mm
Tip diameter: 0.2 mm
10 cm



Sharply curved

No. 15017-10

Ceramic Coated Titanium Castroviejo



•TITANIUM•

For more information
see page 183.

Cutting edge: 5 mm
Tip diameter: 0.2 mm
11 cm



Straight

No. 15650-11



Curved

No. 15651-11

Westcott



Cutting edge: 15 mm
Tip diameter: 0.25 mm
11 cm



Slightly curved

No. 15015-11

Fine Angled Spring Scissors

These spring scissors aid in cutting tissues from various angles.

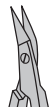

Angled
Cutting edge: 2 mm
Tip diameter: 0.1 mm
9.5 cm

No. 15010-09



Angled
Cutting edge: 4 mm
Tip diameter: 0.125 mm
10 cm

No. 15010-10

Trident II

A re-release of a popular spring scissors now with a new innovative design for a better feel.



Cutting edge: 8 mm
Tip diameter: 0.2 mm
8 cm



Straight

No. 15110-08



Angled

No. 15111-08

Pascheff-Wolff

Very delicate blades.



Cutting edge: 3 mm
Tip diameter: 0.15 mm
10.5 cm



Angled

Moria MC19/B
No. 15371-92



Cutting edge: 5 mm
Tip diameter: 0.2 mm
18.5 cm



Straight

No. 15028-18



Curved

No. 15027-18

Vitreotomy Scissors

The finest blades on spring scissors. Designed for ophthalmic surgery (vitrectomy). The spring handles are made of ribbed plastic to ensure a solid grip. **Autoclavable.**



Cutting edge: 2.5 mm
Tip diameter: 0.175 mm
14.5 cm



200% of actual size

Straight
Microserrations to minimize slippage.

No. 15030-14



200% of actual size

Angled to side

No. 15031-14



14 cm



200% of actual size

Straight
Cutting edge: 2.2 mm
Tip diameter: 0.15 mm

No. 15036-14



200% of actual size

Angled 90°
Cutting edge: 1 mm
Tip diameter: 0.1 mm

No. 15037-14

Ultra Fine Clipper Scissors II

For microscopic dissections of soft and mucous tissue. The minute fineness of the blades allows clear visualization of the tissue being dissected.



Uses:

- Removing sheath of ganglia to access neurons in aplysia.
- Cutting single nerve axons in aplysia, mollusk and snail.
- Stripping fascia off arteries and muscles.
- Ultra fine brain tissue dissection.
- Cutting of minute fiber optic strands.

Blade shape: Triangular
 Blade thickness: 0.1 mm
 Tip thickness: 0.05-0.08 mm
 Cutting edge: 1.5-2 mm
 10 cm

No. 15300-00

Biemer Scissors

These scissors are designed to securely cut vessels without slipping.



Cutting edge: 4 mm
 8.5 cm

No. 15032-08

Cutting edge: 2 mm
 13 cm

No. 15032-13

Extra Fine Bonn

Our finest iris scissors, best suited for microdissection under high magnification.



Straight
8.5 cm



Curved
8.5 cm

Sharp/Sharp
No. 14084-08

Sharp/Sharp
No. 14085-08

MOST POPULAR



Sharp/Blunt
No. 14083-08

Bonn



Straight
Sharp/Sharp
9 cm



Curved
Sharp/Sharp
9 cm

No. 14184-09

No. 14185-09

ToughCut® Bonn-Strabismus

A fusion of two light and delicate iris scissors with ToughCut cutting edges.



For more information see page 183.

ToughCut



Straight
Blunt/Blunt
9 cm

No. 14084-09



Curved
Blunt/Blunt
9 cm

No. 14085-09

Hardened Fine Iris Scissors

These scissors have undergone an extra vacuum hardening process that extends the life of their cutting edges. They have an anti-reflective finish to reduce glare.

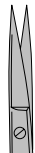

Straight
Sharp/Sharp

9 cm
No. 14090-09

**MOST
POPULAR**

11 cm
No. 14090-11



Curved
Sharp/Sharp

9 cm
No. 14091-09

11 cm
No. 14091-11

Fine Iris Scissors

Made from Martensitic stainless steel, combined with Molybdenum and Vanadium.



Straight
Sharp/Sharp
10.5 cm

No. 14094-11



Curved
Sharp/Sharp
10.5 cm

No. 14095-11

Delicate pattern.



Straight
Sharp/Sharp

9 cm
No. 14060-09

10.5 cm
No. 14060-10

11.5 cm
No. 14060-11



Curved
Sharp/Sharp

9 cm
No. 14061-09

10.5 cm
No. 14061-10

11.5 cm
No. 14061-11

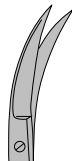

Curved to side
Sharp/Sharp

9 cm
No. 14062-09

10.5 cm
No. 14062-10

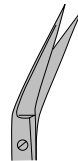

Angled to side
Sharp/Sharp

9 cm
No. 14063-09

11.5 cm
No. 14063-11



Straight
Sharp/Sharp

**LEFT
HANDED**
10.5 cm

No. 14160-10



Curved
Sharp/Sharp

**LEFT
HANDED**
10.5 cm

No. 14161-10

Extra narrow, delicate pattern. Very slim blades with gentle cutting action.



Moria



Straight
Sharp/Sharp
10.5 cm

Moria 4877
No. 14370-22



Shallow curve
Sharp/Sharp
10.5 cm

Moria 4878
No. 14370-23



Side-view showing
extra narrow pattern

Straight
Sharp/Sharp
10.5 cm

No. 14088-10

Wagner



Straight
Sharp/Sharp
Large finger loops
10 cm

No. 14040-10



Curved
Sharp/Sharp
Large finger loops
10 cm

No. 14041-10



Straight
Sharp/Sharp
Non-serrated
12 cm

No. 14068-12



Curved
Sharp/Sharp
Non-serrated
12 cm

No. 14069-12



Straight
Sharp/Sharp
Serrated
12 cm

No. 14070-12



Curved
Sharp/Sharp
Serrated
12 cm

No. 14071-12

ToughCut®



For more information see page 183.

ToughCut



Straight
Sharp/Sharp

9 cm
No. 14058-09

11.5 cm
No. 14058-11



Curved
Sharp/Sharp

9 cm
No. 14059-09

11.5 cm
No. 14059-11

MOST POPULAR

Tungsten Carbide



For more information see page 183.

Tungsten Carbide Cutting Edges



Straight
Sharp/Sharp

9 cm
No. 14568-09

11.5 cm
No. 14568-12



Curved
Sharp/Sharp

9 cm
No. 14569-09

11.5 cm
No. 14569-12

ToughCut® and Tungsten Carbide



For more information
see page 183.



For more information
see page 183.



ToughCut and Tungsten Carbide Cutting Edges



Straight
Sharp/Sharp

9 cm
No. 14558-09

11.5 cm
No. 14558-11



Curved
Sharp/Sharp

9 cm
No. 14559-09

11.5 cm
No. 14559-11

CeramaCut®

These ceramic-coated scissors are the cleanest cutting, longest lasting scissors ever produced. Utilizing the unique properties of a ceramic coating, they will last six times longer than tungsten carbide instruments and cut even better than ToughCut® scissors. The black, corrosion-resistant coating has a non-glare finish.



For more information
see page 183.



CeramaCut



Straight
Sharp/Sharp

9 cm
No. 14958-09

11.5 cm
No. 14958-11



Curved
Sharp/Sharp

9 cm
No. 14959-09

11.5 cm
No. 14959-11

Lexer-Baby



Straight
Sharp/Blunt
10 cm

No. 14028-10



Curved
Sharp/Blunt
10 cm

No. 14029-10



Straight
Blunt/Blunt
10 cm

No. 14078-10



Curved
Blunt/Blunt
10 cm

No. 14079-10

Strabismus



Tungsten Carbide Strabismus



**TUNGSTEN
CARBIDE**

For more information
see page 183.

Tungsten Carbide Cutting Edges



Straight
Blunt/Blunt

9 cm
No. 14074-09

11.5 cm
No. 14074-11



Curved
Blunt/Blunt

9 cm
No. 14075-09

11.5 cm
No. 14075-11



Straight
Blunt/Blunt

9 cm
No. 14574-09

11 cm
No. 14574-11



Curved
Blunt/Blunt

9 cm
No. 14575-09

11 cm
No. 14575-11

Walton



Slightly curved
Sharp/Sharp

9.5 cm
No. 14077-09

10.5 cm
No. 14077-10

Stevens Tenotomy



Straight
Sharp/Sharp
11 cm

No. 14064-11



Straight
Blunt/Blunt
11 cm

No. 14066-11



Curved
Sharp/Sharp
11 cm

No. 14065-11



Curved
Blunt/Blunt
11 cm

No. 14067-11

LaGrange

One edge is serrated to minimize slippage of tissue during cutting. Curved handle helps when cutting from an awkward angle.



Side View



Curved
Sharp/Sharp
11.5 cm

No. 14173-12

Shea

Transplant scissors with light and delicate pattern.



Curved
Blunt/Blunt
12 cm

No. 14105-12

Dissector Scissors

Slim blades for cutting tissue.

Similar to 14081-09, but with stronger blades for cutting fine bone.

Spencer Ligature

Used for cutting stitches or suture.



Angled to side
Sharp/Sharp
Cutting edge: 8 mm
10 cm

No. 14081-09



Angled to side
Sharp/Sharp
Cutting edge: 12 mm
10.5 cm

No. 14082-09



Sharp/Sharp
9 cm

No. 14076-09

Bonn Artery

Iris scissors with one ball tip to prevent piercing of underlying tissue.

Tissue Separating Scissors



Delicate

Sharp/1.5 mm Ball
9 cm

No. 14086-09



Sharp/1.5 mm Ball
11.5 cm

No. 14080-11



Blunt/Blunt
11.5 cm

No. 14072-10

See page 8 for artery-style spring scissors.

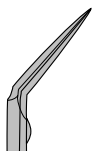
Sharply angled up
Sharp/Sharp
10.5 cm

No. 14037-10

The finger loops can be enlarged to fit almost any size.



Straight
Large finger loops
9.5 cm



Sharp/Sharp
No. 14106-09



Blunt/Blunt
No. 14108-09

Kaye

These scissors have semi-sharp outer edges to better facilitate dissection.



Gently curved
Blunt/Blunt
Serrated
Large finger loops
10.5 cm

No. 14171-10

Standard Pattern

Our standard surgical scissors are recognized for these important features:

- Special alloy that gives their cutting edges long life and superior sharpness.
- Excellent feel and handling capability.
- Overall execution that marks them as fine examples of German workmanship.



Length (cm)	Straight Sharp/Sharp	Straight Sharp/Blunt	Straight Blunt/Blunt
12	No. 14002-12	No. 14001-12	No. 14000-12
13	No. 14002-13	No. 14001-13	No. 14000-13
14.5	No. 14002-14	No. 14001-14*	No. 14000-14
16.5	No. 14002-16	No. 14001-16	No. 14000-16
18.5		No. 14001-18	No. 14000-18
20			No. 14000-20

* Left-handed version also available.



No. 14008-14



Length (cm)	Curved Sharp/Sharp	Curved Sharp/Blunt	Curved Blunt/Blunt
12	No. 14005-12	No. 14004-12	No. 14003-12
13	No. 14005-13	No. 14004-13	No. 14003-13
14.5	No. 14005-14	No. 14004-14	No. 14003-14
16.5	No. 14005-16	No. 14004-16	No. 14003-16
18.5		No. 14004-18	No. 14003-18
20			No. 14003-20

ToughCut® Standard Pattern



ToughCut

Straight
Sharp/Blunt

13 cm
No. 14054-13

17.5 cm
No. 14130-17



For more information
see page 183.

Tungsten Carbide Standard Pattern



Tungsten Carbide Cutting Edges



Straight
Sharp/Sharp
14.5 cm

No. 14502-14



Straight
Sharp/Blunt
14.5 cm

No. 14501-14



Curved
Sharp/Sharp
14.5 cm

No. 14505-14



Curved
Sharp/Blunt
14.5 cm

No. 14504-14



For more information
see page 183.

Standard Pattern with Serrations



Straight
Sharp/Blunt
Serrated
14 cm

No. 14007-14

Standard Pattern with Large Finger Loops



Straight
Sharp/Blunt
Large finger loops
14.5 cm

No. 14101-14

Tungsten Carbide Mini-Lister



For more information see page 183.

Tungsten Carbide Cutting Edges

Angled to side
Blunt/Blunt
Smooth
9 cm

No. 14531-09

Lister

Excellent skin cutting scissors. Longer, blunt blade prevents damaging tissue underneath skin without losing the cutting line.



Angled to side
Blunt/Blunt
Serrated
14 cm

No. 14131-14

Metzenbaum Baby



Straight
Blunt/Blunt

13 cm
No. 14018-13

14.5 cm
No. 14018-14

18 cm
No. 14018-18



Curved
Blunt/Blunt

13 cm
No. 14019-13

14.5 cm
No. 14019-14

18 cm
No. 14019-18

Tungsten Carbide Metzenbaum Fino



**TUNGSTEN
CARBIDE**

For more information
see page 183.

Tungsten Carbide Cutting Edges



Straight
Blunt/Blunt
Ultra fine tips

14.5 cm
No. 14508-15



Straight
Blunt/Blunt

14.5 cm
No. 14518-14

18 cm
No. 14518-18



Curved
Blunt/Blunt
Ultra fine tips

14.5 cm
No. 14509-15



Curved
Blunt/Blunt

14.5 cm
No. 14519-14

18 cm
No. 14519-18

Metzenbaum







ToughCut® Metzenbaum

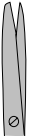
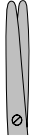

For more information see page 183.

ToughCut

		
Straight Sharp/Blunt	Straight Blunt/Blunt	Curved Blunt/Blunt
14.5 cm No. 14024-14	14.5 cm No. 14016-14	14.5 cm No. 14017-14
	18 cm No. 14016-18	18 cm No. 14017-18

	
Straight Blunt/Blunt	Curved Blunt/Blunt
14.5 cm No. 14116-14	14.5 cm No. 14117-14
18 cm No. 14116-18	18 cm No. 14117-18

Mayo

ToughCut® Mayo

Tungsten Carbide Mayo



TOUGH CUT

For more information see page 183.

TUNGSTEN CARBIDE

For more information see page 183.

ToughCut

Tungsten Carbide Cutting Edges



Straight
Blunt/Blunt

15 cm
No. 14010-15

17 cm
No. 14010-17



Curved
Blunt/Blunt

15 cm
No. 14011-15

17 cm
No. 14011-17



Straight
Blunt/Blunt

15 cm
No. 14110-15

17 cm
No. 14110-17



Curved
Blunt/Blunt

15 cm
No. 14111-15

17 cm
No. 14111-17



Straight
Blunt/Blunt

15 cm
No. 14510-15

17 cm
No. 14510-17



Curved
Blunt/Blunt

15 cm
No. 14511-15

17 cm
No. 14511-17



Straight
Blunt/Blunt
ToughCut

15 cm
No. 14512-15

17 cm
No. 14512-17

Mayo-Stille



Straight
Blunt/Blunt

15 cm
No. 14012-15

17 cm
No. 14012-17



Curved
Blunt/Blunt

15 cm
No. 14013-15

17 cm
No. 14013-17

Mayo-Noble



Straight
Blunt/Blunt
16.5 cm

No. 14014-17



Curved
Blunt/Blunt
16.5 cm

No. 14015-17

Decapitation Scissors

Stop guard at tips to prevent slippage.



80% of
actual size





Straight
Blunt/Blunt
21 cm

No. 14200-21

Friedman-Pearson

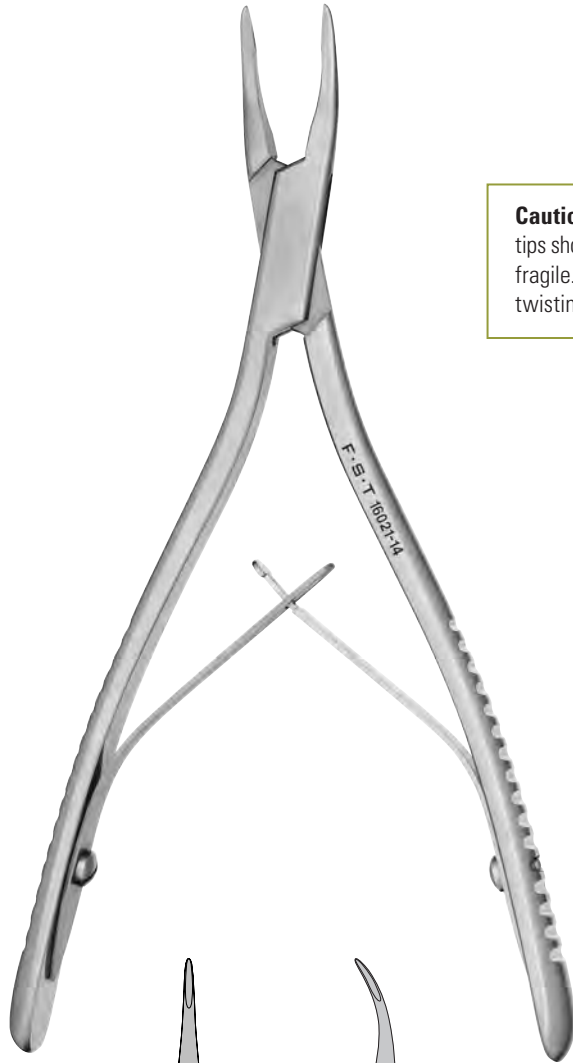
This popular, fine-tipped rongeur is suited for delicate work. The fine-cupped jaws have been designed with a longer and slimmer approach for better visibility.



- | | |
|---|---|
|  |  |
| Straight
14 cm | Curved
14 cm |
| 0.5 mm Cup
No. 16220-14 | 0.5 mm Cup
No. 16221-14 |
| 0.7 mm Cup
No. 16120-14 | 0.7 mm Cup
No. 16121-14 |
| 1 mm Cup
No. 16020-14 | 1 mm Cup
No. 16021-14 |



Cautionary note: The fine rongeur tips shown on this page are extremely fragile. Removal of material with a twisting motion can damage the tips.

MOST POPULAR

Pearson

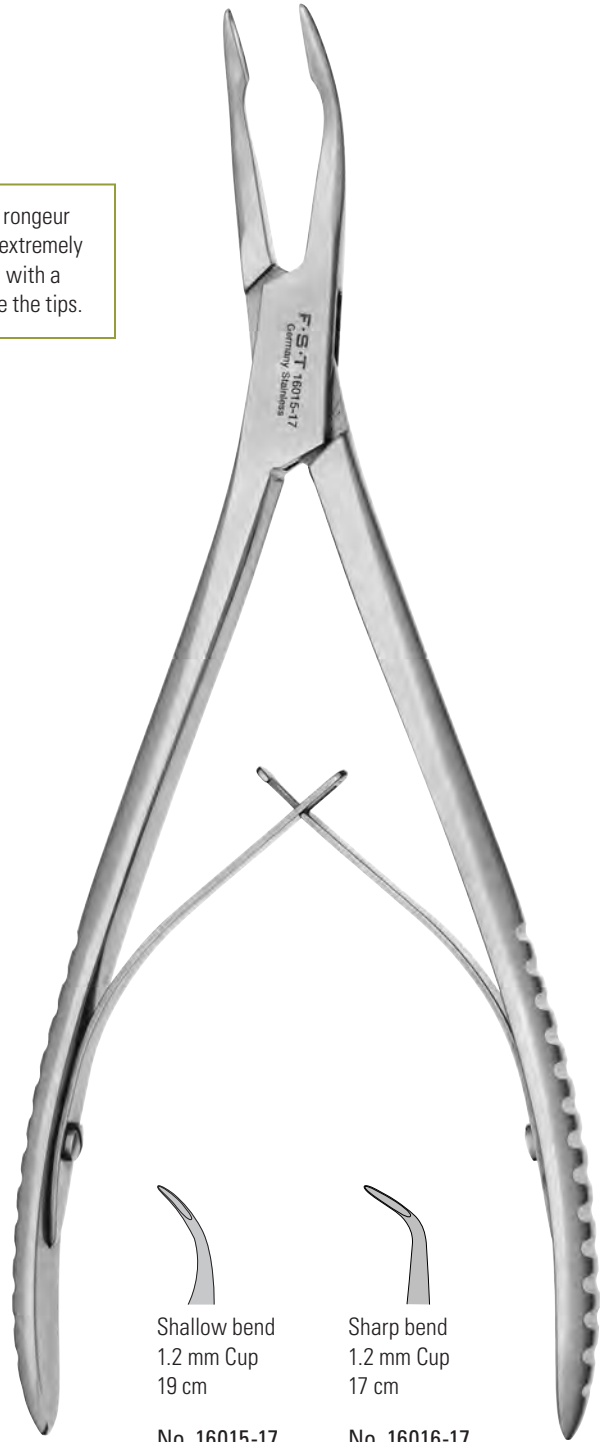
Provides excellent visibility at dissection site due to its extra long and narrow approach to the fine cutting jaws. Especially suitable for larger hands.



- | | |
|---|---|
|  |  |
| Shallow bend
1.2 mm Cup
19 cm | Sharp bend
1.2 mm Cup
17 cm |
| No. 16015-17 | No. 16016-17 |

Baby-Beyer

Double-action rongeur with strong jaws helps relieve hand strain.

Beyer

Double-action rongeur with strong jaws helps relieve hand strain.

Diameter of this circle determines cup size.
 Form an imaginary circle that will fit in the very tip of the instrument and measure its diameter.

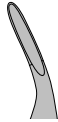

 Straight
 2 mm Cup
 15 cm
 No. 16023-15

 Curved
 2 mm Cup
 15 cm
 No. 16022-15

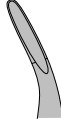

 Curved
 2.5 mm Cup
 18 cm
 No. 16002-18

Friedman

Strong and large jaws are ideal for use on the harder, outer regions of the spinal cord. Also can be used to gain access to delicate structures encased in bone.



Diameter of this circle determines cup size.



Form an imaginary circle that will fit in the very tip of the instrument and measure its diameter.

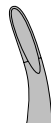

Curved
2.5 mm Cup
13 cm

No. 16000-14

Lempert

Extra fine jaws.



Straight
2.5 mm Cup
16 cm

No. 16004-16

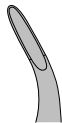

Curved
2.5 mm Cup
16 cm

No. 16005-16

Luer



Curved
4 mm Cup
15 cm

No. 16001-15

Bone Trimmers



Curved
Cutting edge: 8 mm
14 cm

No. 16109-14

Cartilage Cutter

Round cutting blades for tissue, cartilage and soft bone.



Curved
Cutting edge: 9 mm
14 cm

No. 16107-14

Dumont #15a Bone Cutter

Cutting edge on both outside and inside bevel. Cuts suture, cartilage, bone and steel wire to 0.06 mm, and copper wire to 0.15 mm.

Not autoclavable.



Hard carbon steel

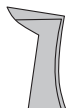

Cutting edge: 10 mm
Jaw opening: 2.5 mm
Hard carbon steel
11.5 cm

No. 11215-01

**Dumont #15a Bone Cutter
Epoxy Coated**

Same structure and functionality as Item No. 11215-01 (left), but with an epoxy coating up to the cutting edge for easier care and maintenance. **Not autoclavable.**



Cutting edge: 6 mm
Jaw opening: 2.5 mm
Epoxy coated carbon steel
11.5 cm

No. 11215-02

Bone Forceps

Strong cross-serrated tips for bone crushing and removal.



Angled
Cross serrated
Tip diameter: 1 mm
11.5 cm

No. 16060-11

Bone Nipper



Angled
Cutting edge: 5 mm
11 cm

No. 16102-11

Offset Bone Nipper

Strong jaws for cutting tough cartilage.



Angled
Cutting edge: 7 mm
10 cm

No. 16101-10

Malleus Nipper

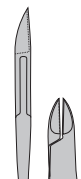

Straight
Serrated
Cutting edge: 9 mm
11 cm

No. 16140-11

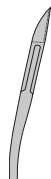

Angled down
Serrated
Cutting edge: 9 mm
11 cm

No. 16141-11

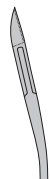

Angled up
Serrated
Cutting edge: 9 mm
11 cm

No. 16142-11

Bone Cutting Spring Scissors



Straight
Cutting edge: 12 mm
13 cm

No. 16144-13

Delicate Bone Cutting Spring Scissors

Slim, strong blades for cutting fine bones and tissues.

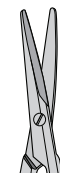

Curved
Cutting edge: 12 mm
12 cm

No. 16143-12

Littauer Bone Cutter



Cutting edge: 15 mm
11 cm
No. 16152-11

Cutting edge: 17 mm
12.5 cm
No. 16152-12

Cutting edge: 19 mm
15 cm
No. 16152-15

Beebe Bone Scissors

Very strong jaws with sharp points.



MOST POPULAR

Straight
Cutting edge: 15 mm
10 cm

No. 16044-10

Tungsten Carbide Bone Scissors

Strong heavy blades for cutting bone.



TUNGSTEN CARBIDE

For more information see page 183.

Tungsten Carbide Cutting Edges

Straight
Cutting edge: 15 mm
12.5 cm

No. 16030-12

Straight
Cutting edge: 15 mm
16 cm

No. 16030-16

Boehler

Bone splitting cutter with very fine tips and double action joint to relieve strain on your hand.



Angled up 10°
Cutting edge: 18 mm
15 cm

No. 16130-15

Skull Flap Cutter

One tip has a flat and narrow platform which fits between dura and skull. Other tip has sharp cutting edge.



Angled up 15°
Cutting edge: 10 mm
15 cm

No. 16050-15

Cleveland Cutter

Liston

Gross anatomy bone cutter.

CUTTERS



Straight

Cutting edge: 14 mm
15 cm
No. 16106-14

Cutting edge: 15 mm
17 cm
No. 16105-16



Straight

Cutting edge: 20 mm
14 cm
No. 16104-14

Cutting edge: 30 mm
20 cm
No. 16104-19

Bone Shears



75% of actual size

Cutting edge: 6.5 cm
24 cm

No. 16150-24

Bone Pliers

To peel back skull flaps.

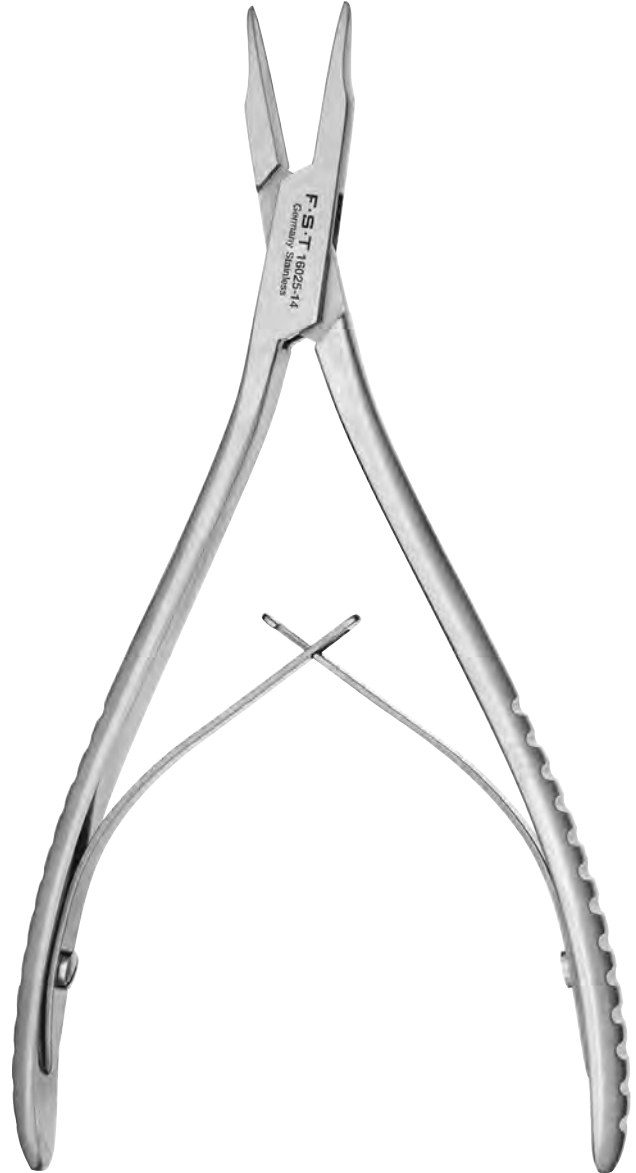

Flat surface
15.5 cm

No. 16025-14

Self-Holding Pin and Bone Screw Forceps

Designed with a serrated tip and grooved cup for a stable and secure grip, these forceps hold pins and screws allowing precise placement at your target area. They are compatible with all Fine Science Tools insect pins, minuten pins and bone screws.



200%

Polished stainless steel
14 cm

No. 26100-00



Miniature Self-Tapping Bone Screws

Used extensively to anchor dental cement to bone, these self-tapping screws have superior holding strength over ordinary machine screws. Stainless steel with fillister flat head.

Shaft diameter: 0.86 mm
Length: 4 mm

Pkg. of 100 screws
No. 19010-10

For pre-drilling use our 0.7 mm burs,
see page 157.

Shaft diameter: 1.19 mm
Length: 4.8 mm

Pkg. of 100 screws
No. 19010-00

For pre-drilling use our 0.9 mm burs,
see page 157.

Bone Wax

A beeswax-based compound for bone hemostasis. Soft, kneadable and ready to use. **Sterile.**



Box of 12 foil packs (2.5 g each)
No. 19009-00

Micro Curette

Curette tips consist of a scoop with sharp edges and are used for scraping or cleaning. They can also be used for separating and transporting, inoculating plates or transferring small amounts of chemicals.



Delicate Bone Scraper

For scraping tissue without cutting into bone.



Austin Chisel

Dissecting Chisel



Serrations on cutting edge

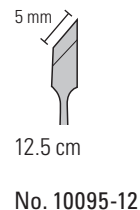
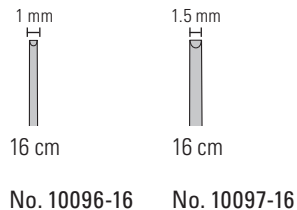
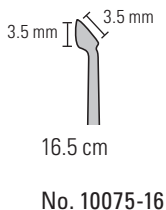
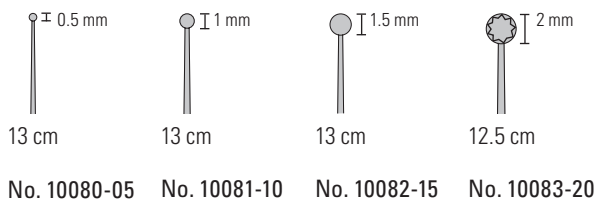

Von Graefe Knife

Used for cutting dura.

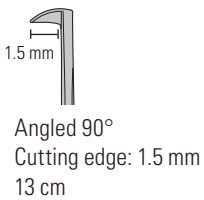

No. 10059-13

One of the most popular dissecting knives with a microfine point. The cutting edge is lance shaped to provide the ideal cutting angle.



Cutting edge: 4 mm
12.5 cm

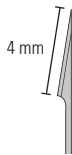

Straight

No. 10055-12

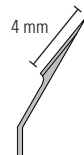

Angled 30°

No. 10056-12

Sichel

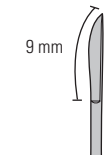

Cutting edge: 9 mm
12 cm

No. 10073-14



Cutting edge: 28 mm
13 cm

No. 10370-13

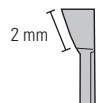

Side blade 20°
Cutting edge: 2 mm
15 cm

No. 10058-15

Circle Knife

Sharp cutting edge around tip.

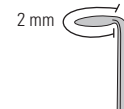

Angled 90°
Cutting edge: 2 mm
16 cm

No. 10059-15

Ceramic Blades

Advantages:

- Ceramic edge stays sharp 100 times longer than steel edge
- Rust and corrosion free
- Chemical and acid resistant
- Withstands up to 2400°C (4352°F)
- No electrostatic discharge concerns
- No trace metal contamination
- Fully nonmagnetic
- **Autoclavable**



Handle

12.5 cm
No. 10025-50



Ceramic Blade

45° Cutting Edge
Cutting edge: 8 mm
33 x 6 x 0.5 mm

Pkg. of 5 blades
No. 10025-45

Diamond Knives

This knife has a gem-quality, neutral diamond blade which is honed to the finest cutting edge possible. The blade is made to an ophthalmic surgical standard and is inspected under 400x magnification. The retractable handle aids in care and storage.

Cautionary note:

This blade is extremely fragile and vulnerable to lateral pressure.



Cutting angle: 30°
No. 10100-30



Cutting angle: 45°
No. 10100-45



Grip slides up the handle to protect the tip for safe storage and packing.

Obsidian Stone Age Scalpels

For applications where extremely fine cuts are required or for studies where trace metals from ordinary scalpel blades cannot be tolerated. These ultra fine cutting edges have been used in human surgical procedures where objectionable scar tissue results from the use of standard scalpels.

The blade is made from obsidian—a type of volcanic glass—which allows a much finer blade than is possible with the conventional steel blade. In some cases this makes the relatively inexpensive obsidian scalpel a suitable substitute for an expensive diamond knife.

Patterned after “stone age” knives which first made their appearance about 18,000 years ago, these modern versions utilize hard wood and plastic dowels for handles. Plastic dowels are made of polyoxymethylene.

Cautionary note:
 Obsidian is a very fragile material. Great care should be taken to not exert any lateral pressure on the blade during cutting. Each blade is hand-fashioned, so sizes, shapes and points will vary. While all the blades will have at least one sharp edge, some will have two.



150%

Wood Dowel
 Straight
Not autoclavable

Approximate blade length: 6 mm
 No. 10110-01

Approximate blade length: 12 mm
 No. 10110-03



150%

Plastic Dowel
 Approximate blade length: 6 mm
Autoclavable

Straight
 No. 10110-05



150%

Plastic Dowel
 Approximate blade length: 6 mm
Autoclavable

Angled
 No. 10110-07

Gross Anatomy Knives

Handles are made of fiberglass reinforced yellow nylon with a slip resistant surface that allows little chance of bacterial accumulation. The blades are made of German Molybdenum Stainless Steel.

40% of actual size



Dissection knife

Cutting edge: 13 cm
28 cm
No. 10157-13

Cutting edge: 15 cm
30 cm
No. 10157-15

Cutting edge: 18 cm
33 cm
No. 10157-18

40% of actual size



Brain sectioning knife

Cutting edge: 30 cm
45 cm
No. 10152-30

Blade Holders and Breakers



Flat surface
 Jaw width: 4 mm
 11 cm
 No. 10052-11

Surface with concave and convex jaws
 Handle diameter: 5.5 mm
 9 cm
 No. 10053-09

Handle diameter: 8 mm
 13 cm
 No. 10053-13

Breakable Carbon Steel Blades

These special, high carbon content blades are the only blades that will break cleanly.



Blade thickness: 0.1 mm

Box of 10 blades
 No. 10050-00

Create Your Own Blade

With these blade holders/breakers and our special carbon steel blades, No. 10050-00, you can produce microblades in sizes that meet your own individual needs.

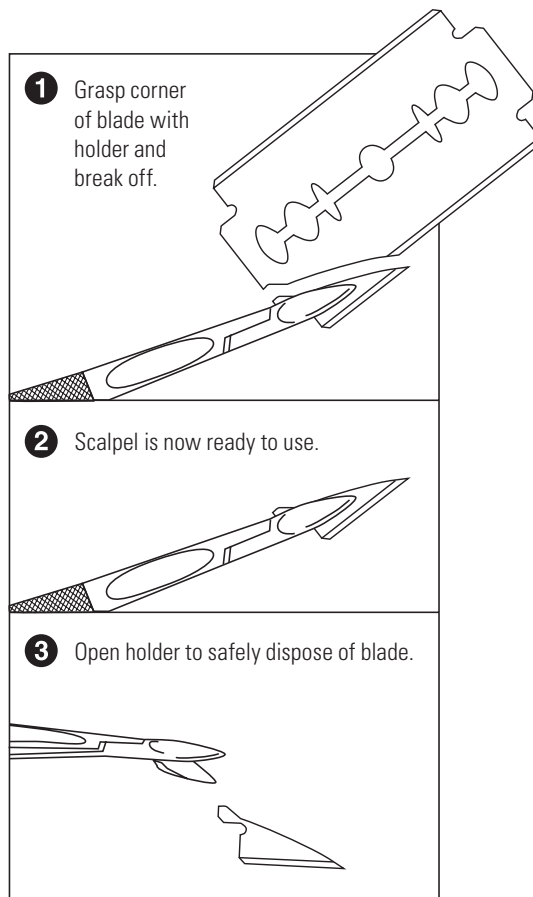

Cold forged from carbon steel and sharpened to eliminate tissue distortion and blade drag. 12.5 cm plastic handle with slip-proof grip. **Sterile.**

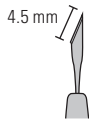

Cutting angle: 22.5°
Tip thickness: 0.15 mm
Cutting edge: 4.5 mm
13.5 cm

No. 10316-14 **MOST POPULAR**



Cutting angle: 15°
Tip thickness: 0.15 mm
Cutting edge: 5 mm
13 cm

No. 10315-12

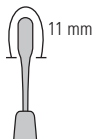

Crescent blade
Tip thickness: 0.20 mm
Cutting edge: 11 mm
14 cm

No. 10317-14



Needle blade
Tip thickness: 0.20 mm
Cutting edge: 4 mm
14.5 cm

No. 10318-14

Interchangeable Carbon Steel Blades



Handle for Interchangeable Blades

9.5 cm
No. 10035-00

12.5 cm
No. 10035-12



Angled blade
Carbon steel
Cutting edge: 10 mm

Pkg. of 5 blades
No. 10035-15



Curved blade
Carbon steel
Cutting edge: 10 mm

Pkg. of 5 blades
No. 10035-20



Small flat blade
Carbon steel
Cutting edge: 1.5 mm

Pkg. of 5 blades
No. 10035-05



Large flat blade
Carbon steel
Cutting edge: 2.75 mm

Pkg. of 5 blades
No. 10035-10



Cane blade
Carbon steel
Cutting edge: 12 mm

Pkg. of 5 blades
No. 10035-25



Arc blade
Carbon steel
Cutting edge: 12 mm

Pkg. of 5 blades
No. 10035-30

Scalpel with Plastic Handle #4

For heavy, gross anatomy work.
Molded to fit hand.



#4 Plastic
13.5 cm
No. 10008-13

Standard Scalpel Handle #4 Solid

Especially suitable for large dissections.



#4 Solid
13 cm
No. 10004-13

Blades for #4 Scalpel Handle

The alloy used has a high carbon content which provides a longer lasting edge. Blades come individually wrapped. **Non-sterile.**



Box of 100 blades
No. 10020-00



Box of 100 blades
No. 10021-00



Box of 100 blades
No. 10022-00



Box of 100 blades
No. 10023-00

Standard Scalpel Handle #3 Solid



#3
12 cm

No. 10003-12



Secure Scalpel Handle #3

A safety lock holds the blade securely, and allows simple and safe blade attachment and removal.



#3
12 cm

No. 10003-13

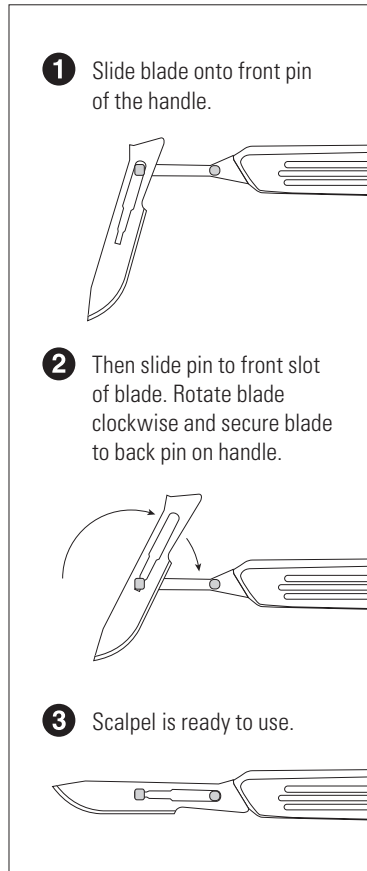

Blades for #3 and #7 Scalpel Handles

The alloy used has a high carbon content which provides a longer lasting edge. Blades come individually wrapped. **Non-sterile.**



Box of 100 blades
No. 10010-00



Box of 100 blades
No. 10011-00



Box of 100 blades
No. 10012-00



Box of 100 blades
No. 10015-00

**Short Scalpel
Handle #7 Solid**



#7 short
12 cm

No. 10007-12

**Standard Scalpel
Handle #7 Solid**



#7 long
16.5 cm

No. 10007-16

Scalpel Blade Remover

For safe removal of scalpel blades, simply insert scalpel with blade into the Scalpel Blade Remover and press the sides together. This will dislodge the blade from handle and hold the blade securely for release.



6.5 cm

No. 10002-00

Scalpel Blade Removal and Disposal Box

This plastic device will remove used scalpel blades safely and retain them for safe disposal. Can be used for blades that fit the #3, #4, #7 and Gross Anatomy handles.

Capacity approximately 80 blades
7.5 x 5 x 2.5 cm

Carton of 10 boxes
No. 10002-50

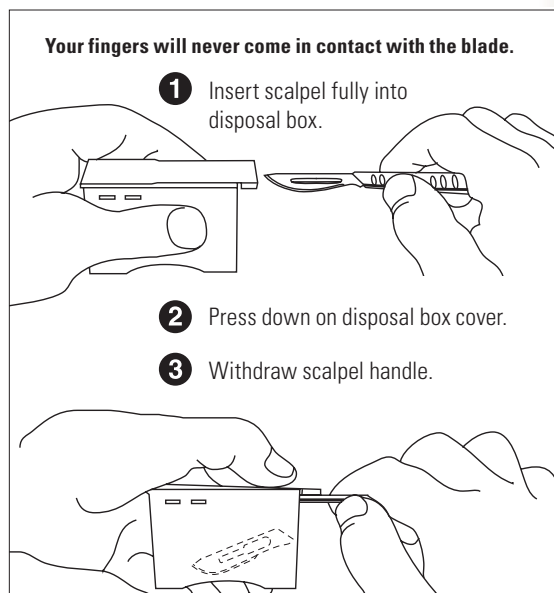

Gross Anatomy Blade and Handle



7.5 cm

Box of 100 blades
No. 10060-00



13 cm

No. 10060-13

Disposable Safety Scalpels

Plastic handle #3 with stainless steel blades. The protective cartridge completely covers the blade for safe, fast, and easy disposal. **Single-use and non-sterile.**

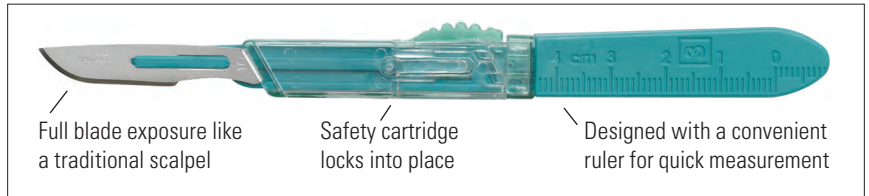

Full blade exposure like a traditional scalpel

Safety cartridge locks into place

Designed with a convenient ruler for quick measurement



#10 scalpels
Pkg. of 10
No. 10000-10



#11 scalpels
Pkg. of 10
No. 10000-11



#15 scalpels
Pkg. of 10
No. 10000-15



Scalpel shown with safety cartridge closed and locked into place.

Plastic handle with stainless steel blades
14 cm

Safety Scalpel Handle #3 and Blade Cartridges

The Safety Scalpel Handle #3 is compatible with all Safety Scalpel Blades. The handle is reusable and made of Teflon coated stainless steel which provides a non-stick surface. The Blade Cartridges are color-coded with clear windows for easy identification. The protective cartridge completely covers the blade for safe, fast, and easy disposal. **Handle is reusable and autoclavable. Blades are single-use and non-sterile.**

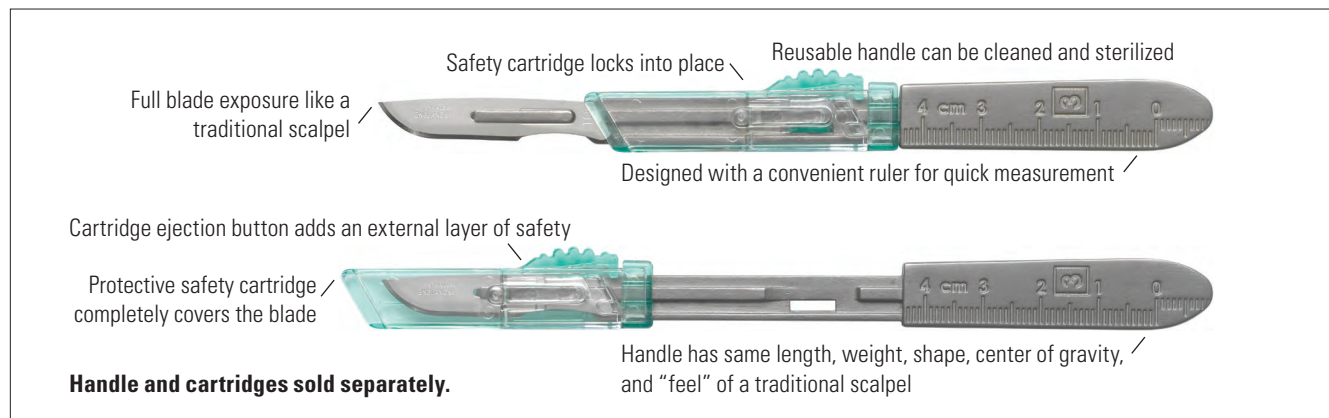

Safety Scalpel Handle #3



Teflon coated stainless steel
12.5 cm

No. 10006-12

Safety Scalpel Blade Cartridges



#10 blades
Pkg. of 10
No. 10010-10



#11 blades
Pkg. of 10
No. 10011-10



#15 blades
Pkg. of 10
No. 10015-10



Scalpel blade shown with safety cartridge closed and not attached to handle.

Safety Scalpel Blade Cartridges shown open and attached to handle.
Handle and cartridges sold separately.



Forceps & Hemostats

Dumont	Pages	63 – 72
Fine	Pages	73 – 80
Moria	Page	74
S&T	Pages	75, 77
Standard	Pages	81 – 91
Hemostats	Pages	92 – 97

See page 189 for alloy and additional information.

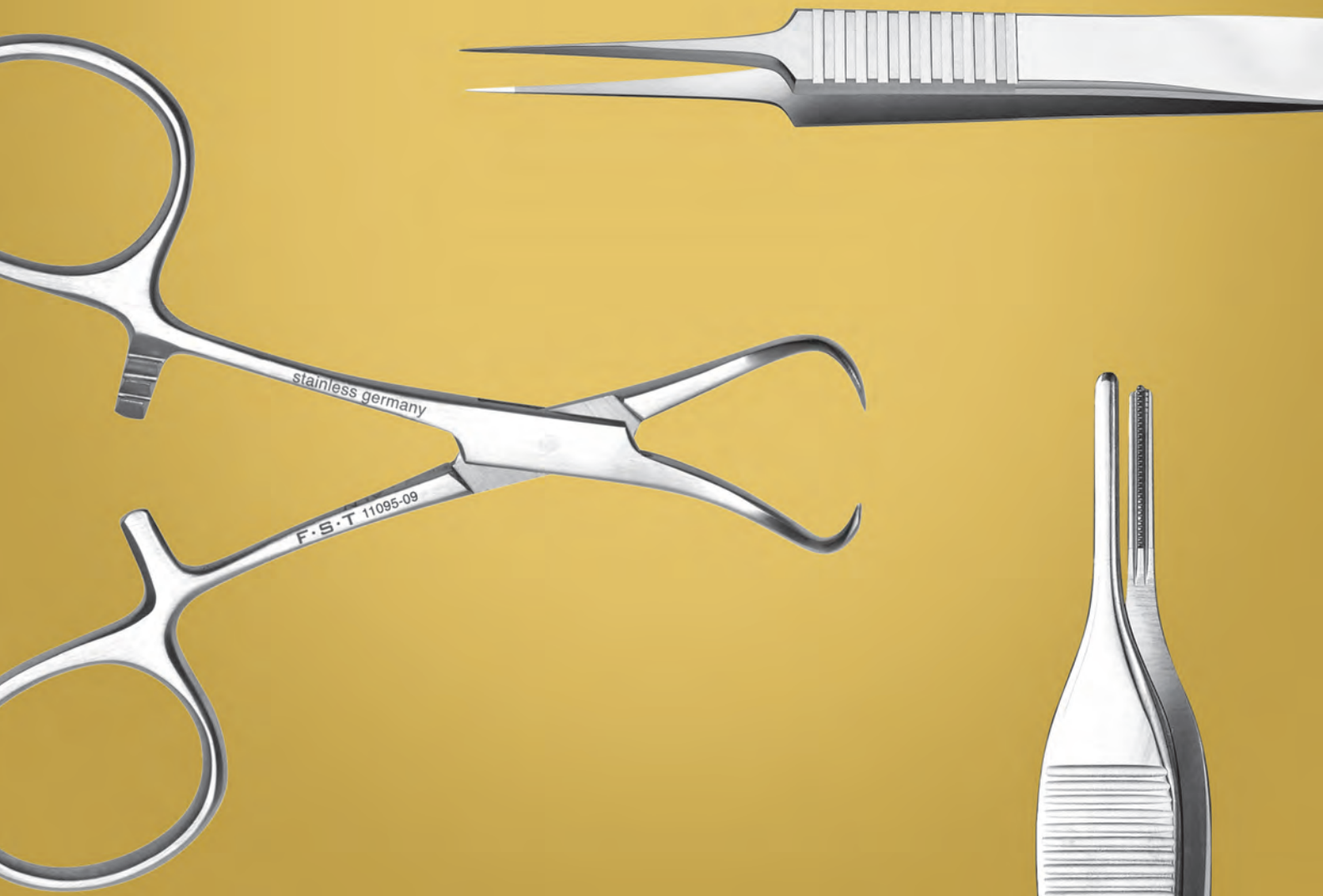

Dumont #5SF

The finest tips ever produced by Dumont.



Super fine tip
0.025 x 0.005 mm
Inox
11 cm

No. 11252-00

**Dumont #5
Fine Tips**

Finished under magnification and polished on the inside, the tips close flat to 3 mm and are less likely to open under excess pressure.



Biology tip
0.05 x 0.01 mm
Inox
11 cm

No. 11254-20

**Dumont #5
Ceramic Coated**

These forceps are non-reflective. The scratch and corrosion resistant coating guarantees durability.



Biology tip
0.05 x 0.01 mm
Ceramic coated inox
11 cm

No. 11252-50

Dumont #5CO

These forceps have been honed down to make this the lightest and most precise Dumont forceps available.



Biology tip
0.05 x 0.01 mm
Dumostar
11 cm

No. 11295-20

For information on Dumont alloys and tip styles, see page 189.

MOST POPULAR

Dumont Micro-Blunted, Atraumatic Tipped Forceps

The sides of these forceps are distinctively ribbed to provide a better holding surface for maximum control of the instrument. The shanks are arched toward each other to transmit more holding strength to the points. The smooth inside surfaces at the tips will close flat to 5 mm with gentle pressure, increasing the total holding area considerably. The microscopically matched tips are gently blunted to prevent tissue puncture and are recommended as micro needle holders.

FORCEPS



Straight
0.10 x 0.06 mm
Inox
11 cm

Medical #5
No. 11253-20



Off-center
0.13 x 0.08 mm
Inox
11.5 cm

Medical #5A
No. 11253-21



Short curve
0.17 x 0.10 mm
Inox
12 cm

Medical #7S
No. 11273-22

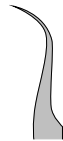

Curved
0.17 x 0.10 mm
Inox
11.5 cm

Medical #7
No. 11273-20



Angled 45°
0.10 x 0.06 mm
Inox
11 cm

Medical #5/45
No. 11253-25



Angled 90°
0.10 x 0.06 mm
Inox
11 cm

Medical #5/90
No. 11253-29

Dumont #55

Bevelled, like #5 but with extra light and fine shanks.



Biology tip
0.05 x 0.02 mm
11 cm

Inox
No. 11255-20

Dumostar
No. 11295-51

**Dumont #5
Mirror Finish Forceps**

The last 5 mm on the inside of the tips are highly polished to help prevent tissue from sticking. Ideal for embryos, nerves, or any other adhesive tissue.



Standard tip
0.10 x 0.06 mm
Inox
11 cm

No. 11251-23

Biology tip
0.05 x 0.02 mm
Inox
11 cm

No. 11252-23

For information on Dumont alloys and tip styles, see page 189.

Dumont #5

These are the most widely used Dumont forceps. Bevelled, very fine shanks for best visibility.



Standard tip
0.10 x 0.06 mm
11 cm

Inox
No. 11251-20

Dumoxel
No. 11251-30

Dumostar
No. 11295-00

Carbon
0.08 x 0.04 mm
Not autoclavable
No. 11251-10

Biology tip
0.05 x 0.02 mm
11 cm

Inox
No. 11252-20

Dumoxel
No. 11252-30

Dumostar
No. 11295-10

TITANIUM
No. 11252-40

MOST POPULAR

MOST POPULAR

Dumont WA #5

These newly designed forceps offer improved stability with an ergonomic body that allows the forceps to fit more comfortably in your hand. A domed end with no soldering grooves allows the forceps to be thoroughly and easily cleaned, preventing biofilm residues.

Dumont #5XL

For information on Dumont alloys and tip styles, see page 189.



Side View

Standard tip
0.10 x 0.06 mm
Inox
12 cm

No. 11251-21

Biology tip
0.05 x 0.02 mm
Inox
12 cm

No. 11252-21



Standard tip
0.10 x 0.06 mm
Inox
15 cm

No. 11253-10

Dumont #L5

Slide sleeve keeps tips together so specimens may be securely held and retained. Slide may be locked in place so that forceps can be used in regular fashion. **Autoclavable.**



Standard tip
0.10 x 0.06 mm
Inox
11 cm

No. 11253-27

**Dumont #5
Teflon® Coated**

These antimagnetic forceps are ideal for use in cryogenic environments and for EM samples.



Standard tip
0.10 x 0.06 mm
Teflon coated inox
11 cm

No. 11626-11

Dumont #5/45

45° tips for improved visibility and control.



Standard tip
0.10 x 0.06 mm
Dumoxel
11 cm

No. 11251-35

MOST POPULAR

**Dumont #5/45
Cover Slip Forceps**

Designed to pick up cover slips out of multi-well plates. The tip width is squared for a better grip.



400%

1 mm from tip to bend
Upper tip: 0.10 x 0.08 mm
Lower tip: 0.10 x 0.02 mm
Dumoxel
11.5 cm

No. 11251-33

Dumont #3

Tapered and sturdy shanks.



Standard tip
0.17 x 0.10 mm
12 cm

Dumoxel
No. 11231-30

Dumostar
No. 11293-00

Dumont #3c



Standard tip
0.17 x 0.10 mm
Inox
11 cm

No. 11231-20

Dumont #6

Sharply angled tips for access to difficult areas.



Standard tip
0.17 x 0.10 mm
Inox
11.5 cm

No. 11260-20

**Dumont #7
Fine Tips**

Finished under magnification and polished on the inside, the tips close flat to 3 mm and therefore less likely to open under excess pressure.



For information on Dumont alloys and tip styles, see page 189.

Biology tip
0.07 x 0.03 mm
Inox
11 cm
No. 11274-20

Dumont #7



Standard tip
0.17 x 0.10 mm
11.5 cm
Dumoxel
No. 11271-30

Dumostar
No. 11297-00

•TITANIUM•

No. 11272-40

**Dumont #7
Ceramic Coated**



Biology tip
0.07 x 0.04 mm
Ceramic coated inox
11 cm
No. 11272-50

Dumont #7B



Standard tip
Serrated
0.17 x 0.10 mm
Inox
11 cm
No. 11270-20

FORCEPS

Dumont #4

Similar to #5, but with broader shanks.



Standard tip 0.13 x 0.08 mm Dumoxel 11 cm No. 11241-30	Biology tip 0.06 x 0.04 mm Dumoxel 11 cm No. 11242-40
--	---

Dumostar
No. 11294-00

**Dumont #2
Laminectomy Forceps**

These forceps can be used to break off delicate bone during mouse laminectomies, as well as fine skull bone removal.



0.40 x 0.02 mm
Inox
12 cm
No. 11223-20

**Dumont #2AP
Epoxy Coated**

Provides good insulation for up to 220 AC voltage work and highly impervious to chemical solutions. Frozen or super cold sections will not adhere to the gripping surfaces.



Tip width: 1.5 mm
Epoxy coated Inox
12 cm
No. 11220-21

Dumont AA

**Dumont AA
Epoxy Coated**

Slip-proof acid and electric shock resistant epoxy coating covering 17.5 mm from the tips.

Dumont SS

The tips are smooth on the inside for a gentle grip. Applying full strength will not separate tips and a strong hold on the smallest specimen is ensured.

For information on Dumont alloys and tip styles, see page 189.



0.4 x 0.2 mm
Inox
12.5 cm

No. 11210-20

0.4 x 0.2 mm
Epoxy coated inox
12.5 cm

No. 11210-10

Standard tip
0.20 x 0.12 mm
Inox
13.5 cm

No. 11203-23

Biology tip
0.10 x 0.06 mm
Dumoxel
13.5 cm

No. 11200-33



Angled 45°

No. 11203-25

FORCEPS

Dumont Mini Forceps



0.12 x 0.07 mm Inox 7 cm Style 3 No. 11200-10	0.14 x 0.06 mm Inox 7 cm Style 4 No. 11200-12	0.09 x 0.05 mm Inox 8.2 cm Style 5 No. 11200-14
---	---	---

Fine Forceps Repair Kit

Realign and repair fine forceps with this convenient kit. Bent forceps tips can be restraightened with the chain nose pliers. The sharpening stone has two grooves, 1.6 mm and 0.8 mm, to assist in reshaping the forceps tips. O-rings clamp the forceps shut to ensure that both shanks are equally aligned and sharpened. Instrument oil assists in producing a smooth sharp edge. Detailed instructions are included.



Kit includes:

- 1 Sharpening stone for fine forceps with ten O-rings (No. 29008-22)
- 1 Instrument oil, 50 ml bottle (No. 29055-00)
- 1 Chain nose pliers

No. 29000-00 **MOST POPULAR**

O-Rings for Forceps

These rubber O-rings fit our forceps and keep them closed with variable degrees of pressure on the tips.

Pkg. of 10
No. 11200-00



Fine Forceps Mirror Finish

The last 5 mm on the inside of the tips are highly polished to help prevent tissue from sticking. Ideal for embryos, nerves, or other adhesive tissue.



0.10 x 0.06 mm
11 cm
No. 11412-11

0.05 x 0.02 mm
11 cm
No. 11413-11

Fine Forceps Broad Shanks

Straight forceps with sturdy coarse tips.



0.2 x 0.12 mm
12 cm
No. 11445-12

Fine Forceps Self-Closing

Ideal for lifting and holding EM grids. Consistent pressure at tips. Correctly tensioned "cross-over" shanks come to a microscopically matched point.



0.08 x 0.04 mm
11.5 cm
No. 11480-11



0.10 x 0.06 mm
11 cm
No. 11485-11



0.20 x 0.12 mm
11.5 cm
No. 11487-11

FORCEPS

These forceps have the most finely executed points available. They are extremely light, superbly balanced, and have a gentle spring action. The shanks are specially designed with an arch which ensures maximum force to the tips. The tips close flat for 6 mm from the points to give a large holding area. The tips have been expertly finished under magnification.

FORCEPS



Moria



Moria



Moria

Tip width: 0.5 mm
Blunt
10 cm

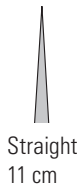

Straight
11 cm

Moria MC40
No. 11370-40



Curved
11 cm

Moria MC40/B
No. 11370-42



Straight
13 cm

Moria 9980
No. 11399-80



Curved
13 cm

Moria 9987
No. 11399-87



Smooth
Moria MC32/B
No. 11373-22



Smooth
Moria MC31/B
No. 11373-12



Microerrated
Moria MC32
No. 11370-32



Microerrated
Moria MC31
No. 11370-31

SuperGrip Forceps

The tips are processed with MicroCrystals[®], a method developed by S&T[®] to infuse tungsten carbide on stainless steel. The formation of this ultra-fine coating guarantees atraumatic handling of tissue while improving the grip dramatically. The recommended use is where forceps are utilized as needle holders or when slippery tissues might be encountered.



S&T[®]

0.3 x 0.25 mm
11 cm

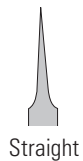

Straight

No. 00108-11



Angled 45°

No. 00109-11



The gripping surface is similar to a match head.

S&T[®]

0.3 x 0.25 mm
11 cm



Straight

No. 00632-11



Angled 45°

No. 00649-11

Bonn

The 1x2 forceps are the finest of their kind available.

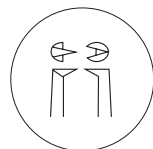

20x magnification

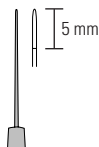

Smooth
Tip width: 0.3 mm
Tip platform: 5 mm
7 cm

No. 11083-07

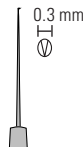

1x2 teeth
Tip width: 0.45 mm
Teeth width: 0.1 mm
7 cm

No. 11084-07

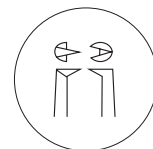

20x magnification

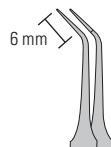

Angled 45°
Tip width: 0.4 mm
Platform
9 cm

No. 11063-07

**Mirror Finish
Suture Tying Forceps**

A unique tip style fusing a suture tying platform and a 1x2 teeth tip for tissue manipulation.

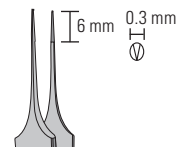

Straight
Tip width: 0.3 mm
Platform with 1x2 teeth
9 cm

No. 11090-09

Suture Tying Forceps

The platform tips close flat. This ensures a reliable grip on sutures.

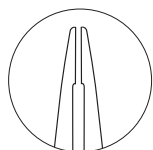

Tip diameter: 0.3 mm
Tying platform: 6 mm
13.5 cm

No. 00272-13

Suture Tying Forceps

The platform tips close flat. This ensures a reliable grip on sutures.

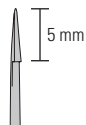

Tip diameter: 0.5 mm
Tying platform: 5 mm
10 cm

No. 18025-10

Round Handled Suture Tying Forceps

Round handles allow easy fingertip adjustments.

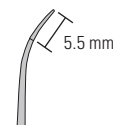

Tip diameter: 0.35 mm
Tying platform: 5.5 mm
10.5 cm

No. 18026-10

Vial Forceps

Tips taper for 6 cm allowing easy access to specimens in vials.

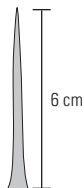
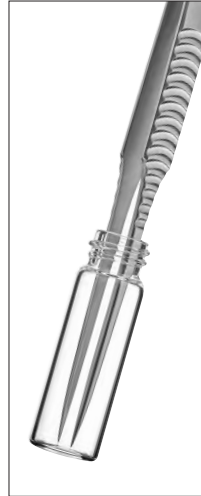

Tip diameter: 0.5 mm
15 cm

No. 11006-15

Vetro Grasping Forceps

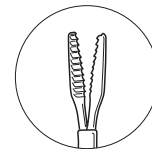

Serrated
Tip diameter: 0.7 mm
14 cm

No. 11900-14

Bishop-Harman

Extra light, fenestrated handles ensure a good grip.



Tip width: 0.6 mm
7 cm



Straight
Serrated

No. 11064-07



Curved
Serrated

No. 11065-07

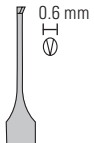

Straight
1x2 teeth

No. 11066-07

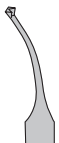

Curved
1x2 teeth

No. 11067-07

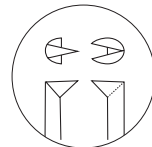

10x magnification



Tip width: 0.5 mm
8.5 cm



Serrated

No. 11069-08

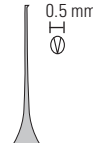

1x2 teeth

No. 11070-08

Octagon Forceps

The octagon shaped grip provides a particularly secure finger hold.



Tip width: 0.8 mm
9.5 cm



Straight
Serrated

No. 11040-08



Curved
Serrated

No. 11041-08

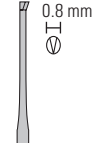

Straight
1x2 teeth

No. 11042-08



Curved
1x2 teeth

No. 11043-08

Extra Fine Graefe Forceps

















Tip width: 0.5 mm
10 cm

Graefe Forceps

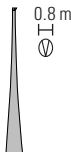

Tip width: See below
10 cm

- | | | |
|---|---|---|
|  |  |  |
| Serrated
No. 11150-10 | Serrated
No. 11151-10 | Serrated
No. 11152-10 |
|  |  |  |
| Smooth
No. 11158-10 | Smooth
No. 11159-10 | Smooth
No. 11160-10 |
|  |  |  |
| 1x2 teeth
No. 11153-10 | 1x2 teeth
No. 11154-10 | 1x2 teeth
No. 11155-10 |

- | | | | |
|---|---|---|---|
|  |  |  |  |
| Serrated
Tip width: 0.8 mm
No. 11050-10 | Serrated
Tip width: 0.8 mm
No. 11051-10 | Serrated
Tip width: 0.8 mm
No. 11052-10 | Serrated
Tip width: 0.8 mm
No. 11049-10 |
| ·TITANIUM·
Tip width: 1.2 mm
No. 11650-10 | ·TITANIUM·
Tip width: 1.2 mm
No. 11651-10 | ·TITANIUM·
Tip width: 1.2 mm
No. 11652-10 | |
|  |  |  | |
| 1x2 teeth
Tip width: 0.8 mm
No. 11053-10 | 1x2 teeth
Tip width: 0.8 mm
No. 11054-10 | 1x2 teeth
Tip width: 0.8 mm
No. 11055-10 | |

For more information
see page 183.

The tips of these forceps arch toward each other, closing flat. Exceptional gripping power is possible with minimal damage to tissue. A limit pin prevents excessive applied pressure.



Slide lock
Smooth
Tip width: 1 mm
11 cm

No. 11062-10



Tip thickness: 0.2 mm
10 cm

No. 11071-10

Pierce Fixation Forceps

For exceptional gripping power with no damage to sclera, vascular sheath and epineurium.



Tissue retention hole of 0.3 mm behind tips.

Straight
0.1 x 0.4 mm
13 cm

No. 18155-13

Plastic Forceps

These forceps are non-magnetic, acid resistant and able to withstand temperatures up to 240°C (464°F). Tips do not spread under pressure.



Acetyl
11.5 cm
Pkg. of 10 forceps



Sharp straight
0.40 x 0.25 mm

No. 11700-00



Blunt straight
1.5 x 0.40 mm

No. 11700-03



Sharp curved
0.30 x 0.20 mm

No. 11700-01



Blunt curved
1.5 x 0.40 mm

No. 11700-04

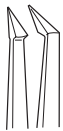

Sharp 45°
0.30 x 0.20 mm

No. 11700-02

Cross Action Forceps

These tissue transport forceps have a gentle action.

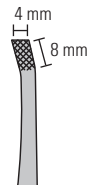

Cross serrated
Tip width: 4 mm
Tip depth: 8 mm
10 cm

No. 11075-00

Cover Glass Forceps



10.5 cm

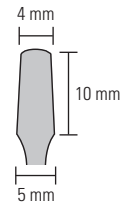

Straight

No. 11074-02

Angled

No. 11073-10

Ring Forceps

For transport of tissue and organs. With limit screw to prevent excessive applied pressure.



ID: 1 mm	ID: 2.2 mm	ID: 4.8 mm
OD: 1.5 mm	OD: 3 mm	OD: 6 mm
8.5 cm	9 cm	9 cm
No. 11101-09	No. 11103-09	No. 11106-09

Circle Forceps

Cupped forceps for atraumatic gripping of organs and tissues.



Tip diameter: 0.7 mm
11.5 cm
No. 11072-11

Live Insect Handling Forceps

Very delicate.



Narrow	Wide
10 cm	10 cm
No. 26029-10	No. 26030-10

Micro-Adson

Our most delicate version of the popular Adson forceps.



Tip width: 0.8 mm
12 cm

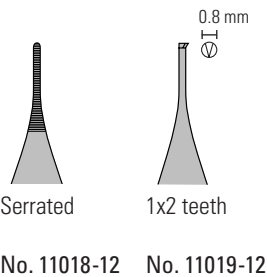

Micro-Adson with Fenestrated Handle

Our delicate Micro-Adson forceps, with five windows to aid in stability and easy finger adjustments.



12 cm

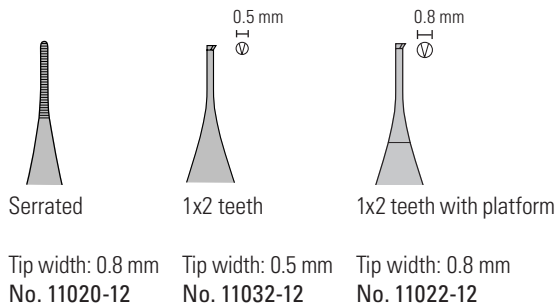

Adson

Wide, strong grip with narrow tips.



Tip width: 1.5 mm
12 cm

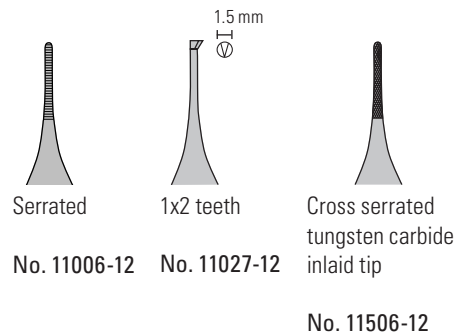

**TUNGSTEN
CARBIDE**

For more information
see page 183.

Adson DeBakey



Atraumatic DeBakey Serrations

This tooth pattern, as shown, consists of one row of atraumatic teeth meshed with two opposite rows of atraumatic teeth.

These two forceps are ideal for gentle, atraumatic gripping of vessels, tissue and other delicate structures.



DeBakey serrations
Tip width: 1.5 mm
12.5 cm

No. 11617-12



DeBakey serrations
Tip width: 1.5 mm
15 cm

No. 11616-15

Adson-Graefe



Fine sharp teeth
Tip width: 4.5 mm
12.5 cm

No. 11030-12

Adson-Brown

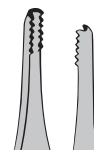

Shark teeth
Tip width: 1.4 mm
12 cm

No. 11627-12

FORCEPS

Semken

Slim pattern with long, narrow shanks and gentle spring action.

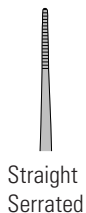

Tip width (mm)	Length (cm)	Item	Price
1.3	13	No. 11008-13	
1.5	15	No. 11008-15	

•TITANIUM•

1.5	15	No. 11608-15	
-----	----	--------------	--

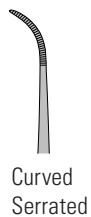

Tip width (mm)	Length (cm)	Item	Price
1.3	13	No. 11009-13	
1.5	15	No. 11009-15	



Narrow Pattern

Lighter spring action than standard pattern for grasping more delicate tissue.

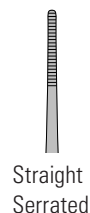

Tip width (mm)	Length (cm)	Item	Price
2	12	No. 11002-12	
2.15	13	No. 11002-13	
2.25	14.5	No. 11002-14	
2.35	16	No. 11002-16	
2.4	18	No. 11002-18	
2.75	20	No. 11002-20	
3.2	25	No. 11002-25	

•TITANIUM•

2.25	14.5	No. 11602-14	
------	------	--------------	--

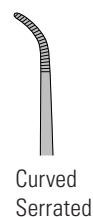

Tip width (mm)	Length (cm)	Item	Price
2	12	No. 11003-12	
2.15	13	No. 11003-13	
2.25	14.5	No. 11003-14	
2.35	16	No. 11003-16	
2.4	18	No. 11003-18	
2.75	20	No. 11003-20	



•TITANIUM•

For more information see page 183.

Standard Pattern

Broad pattern with strong spring action.

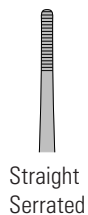

Tip width (mm)	Length (cm)	Item	Price
2.5	12	No. 11000-12	
2.8	13	No. 11000-13	
3.25	14.5	No. 11000-14	
3.3	16	No. 11000-16	
3.7	18	No. 11000-18	
3.75	20	No. 11000-20	
3.9	25	No. 11000-25	
4	30	No. 11000-30	

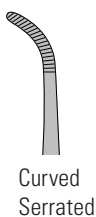

Tip width (mm)	Length (cm)	Item	Price
2.5	12	No. 11001-12	
2.8	13	No. 11001-13	
3.25	14.5	No. 11001-14	
3.3	16	No. 11001-16	
3.7	18	No. 11001-18	
3.75	20	No. 11001-20	



Mouse Handling Forceps

Long handles make picking up small rodents easy and help prevent bites.



Forceps with serrated silicone tips
Gripping surface: 15 x 20 mm
21 cm

No. 11036-20



Replacement silicone tips

Pkg of 2 tips
No. 11036-90

FORCEPS



Slim 1x2 teeth

10 cm No. 11023-10
14.5 cm No. 11023-14

12 cm No. 11023-12
15.5 cm No. 11023-15



1x2 teeth

12 cm No. 11021-12

14.5 cm No. 11021-14

15.5 cm No. 11021-15



2x3 teeth

14.5 cm No. 11022-14

15.5 cm No. 11022-15



1x2 teeth

14 cm No. 11029-14

Used with rongeur No. 16021-14 (page 36) in laminectomy to securely hold spinal column.

Gillies

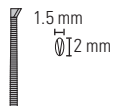

Serrated
1x2 teeth
15 cm

No. 11028-15

Russian

Special cupped pattern
for superior grip.

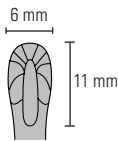

15 cm

No. 11026-15

Organ Holding Forceps

With limit screw to prevent
excessive applied pressure.

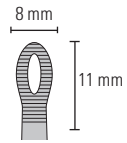

Serrated
14.5 cm

No. 11031-15

London Forceps

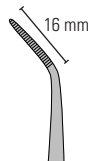

Angled
Serrated
16 cm

No. 11080-02

Titanium Forceps



·TITANIUM·

For more information
see page 183.



Straight
Serrated
16 cm

No. 11602-16

Gerald Forceps



Straight
Serrated
18 cm

No. 11014-18

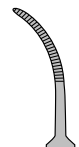

Curved
Serrated
18 cm

No. 11015-18

Taylor Forceps

Serrated and smooth versions available.



Straight
Serrated
17 cm

No. 11010-17



Curved
Serrated
17 cm

No. 11011-17



Straight
Smooth
17 cm

No. 11016-17



Curved
Smooth
17 cm

No. 11017-17

Potts-Smith Forceps



Straight
Serrated

18 cm
No. 11012-18

21 cm
No. 11012-21

25 cm
No. 11012-25



Curved
Serrated

18 cm
No. 11013-18

21 cm
No. 11013-21



Straight
1x2 teeth
18 cm

No. 11024-18



Curved
1x2 teeth
18 cm

No. 11025-18

Ultra Fine Hemostat



Tip width: 0.6 mm
Smooth
12 cm



Straight

No. 13020-12



Curved

No. 13021-12

Fine Hemostat



Tip width: 1 mm
Smooth
12 cm



Straight

No. 13006-12



Curved

No. 13007-12

Micro-Mosquito



Tip width: 1.3 mm
Serrated
12 cm

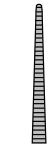

Straight

No. 13010-12



Curved

No. 13011-12

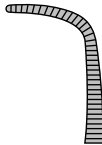

Angled 90°

No. 13012-12

Halsted-Mosquito



Tip width: 1.1 mm
Serrated
12.5 cm

Tip width: 1 mm
Serrated
Left handed
12.5 cm



Straight

No. 13008-12



Curved

No. 13009-12



Straight

No. 13108-12
LEFT HANDED



Curved

No. 13109-12
LEFT HANDED

HEMOSTATS

Crile



Tip width: 1.5 mm
Serrated
14 cm



Straight

No. 13004-14

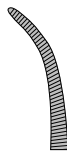

Curved

No. 13005-14

Kelly



Tip width: 1.5 mm
Serrated
14 cm



Straight

No. 13018-14

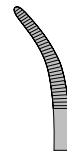

Curved

No. 13019-14

Baby-Mixer



Tip width: 1.3 mm
Serrated
14 cm

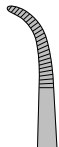

Curved

No. 13013-14

Providence-Hospital



Tip width: 1.5 mm
Serrated
14 cm



Straight

No. 13014-14



Curved

No. 13015-14

HEMOSTATS

Hartman



Tip width: 1 mm
Serrated
10 cm



Straight

No. 13002-10



Curved

No. 13003-10

MOST POPULAR

Backhaus Towel Forceps



9 cm

No. 11095-09



13 cm

No. 11095-13

Allis Forceps

Tissue and organ holding forceps.

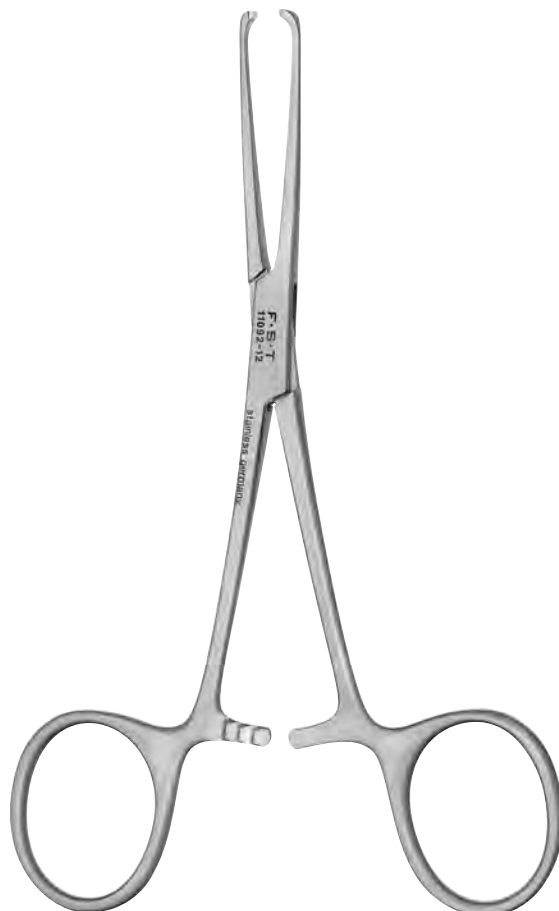
 4 mm

5x6 teeth
Tip width: 4 mm
15 cm

Allis
No. 11091-15

 3 mm

4x5 teeth
Tip width: 3 mm
12 cm

Allis-Baby
No. 11092-12



Probes, Needle Holders, Wound Closure, Retractors & Clamps

Probes & Hooks	Pages	99 – 103
Spatulae	Pages	102 – 105
Pins & Holders	Pages	106 – 107
Spoons	Page	108
Featured Products	Page	109
Wound Closure	Pages	110 – 121
Retractors	Pages	122 – 129
Vascular Instruments	Pages	130 – 139

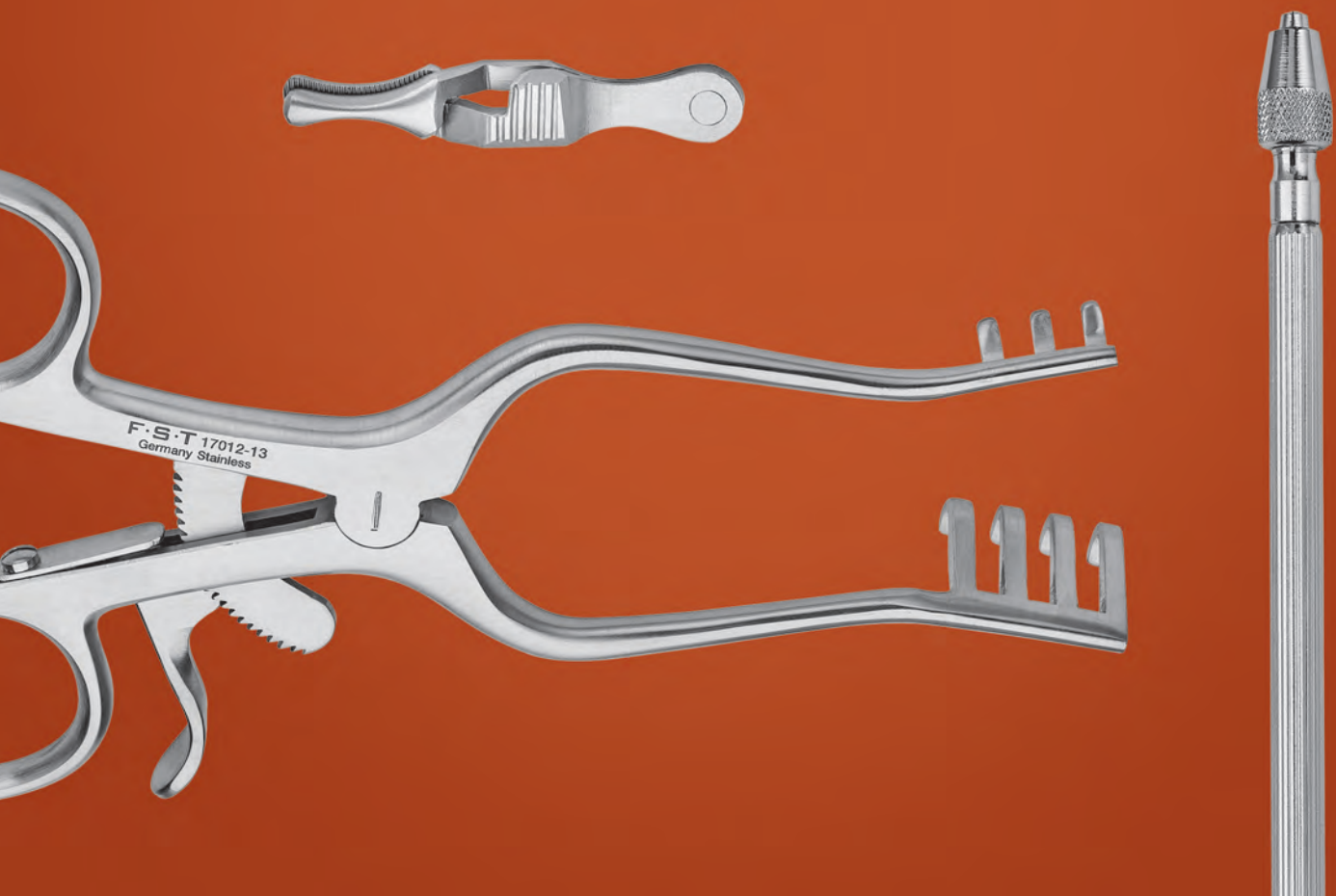

Double Pronged Pick

For peritoneum, pleura, endocardium, organ capsules and skin. Grasps and lifts skin, tissue and dura, etc.

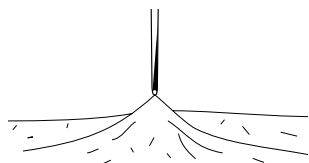

The tip consists of two very sharp, nearly horizontally opposed points. By applying gentle downward pressure and twisting slightly in a clockwise fashion, the points will embed themselves horizontally into fine membranes or skin, etc., so that it may be lifted upward. This instrument also has been used successfully when separating fine tissue from an underlying area that is not to be cut.



11 cm

No. 18067-11

Spinal Cord Hook

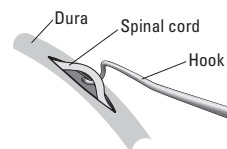

Shaped like a ligation aid and sized to isolate the spinal cord from the dura of adult mice and neonatal rats. The cord can then be cut with minimal damage to the dura.



250%

Tip diameter: 3 mm
12 cm

No. 10162-12

Bonn Micro Probes



Length: 13.5 cm



Actual size

Straight
Tip diameter: 0.025 mm

No. 10030-13



Magnification size

Angled 45°
Tip diameter: 0.025 mm

No. 10032-13



Actual size

Curved
Tip diameter: 0.025 mm

No. 10031-13



Actual size

Large curve
Tip diameter: 0.038 mm

No. 10033-13

Micro Points



Length: 15.5 cm



200%

Angled 90° short
Tip diameter: 0.05 mm

No. 10063-15



200%

Angled 90°
Tip diameter: 0.02 mm

No. 10065-15



200%

Angled 45°
Tip diameter: 0.038 mm

No. 10066-15

Probes and Explorers



Length: 15.5 cm



Actual size

Straight
Tip diameter: 0.25 mm

No. 10140-01 **MOST POPULAR**



Actual size

Short angle
Tip diameter: 0.12 mm

No. 10140-04



Actual size

Angled
Tip diameter: 0.15 mm

No. 10140-02



Actual size

Long angled
Tip diameter: 0.15 mm

No. 10140-03

Micro Hooks



Length: See below



175%

Short round hook
Tip diameter: 0.05 mm
Length: 13 cm

No. 10064-14



175%

Sharp hook
Tip diameter: 0.075 mm
Length: 12 cm

No. 10061-12



175%

Blunt hook
Tip diameter: 0.30 mm
Length: 12 cm

No. 10062-12

Titanium Micro Point, Y-Hook, and Spatula

These instruments are lightweight, color coded for easy identification, have an ergonomic design and a non-reflective surface.

Micro Point



·TITANIUM·
For more information see page 183.

Y-Hook



·TITANIUM·
For more information see page 183.

Micro Spatula



·TITANIUM·
For more information see page 183.



Angled 45°
Tip diameter: 0.4 mm
Titanium
12.5 cm

No. 10165-11

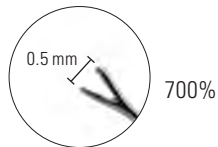

Angled 45°
Tip width: 0.5 mm
Titanium
12.5 cm

No. 10166-11



Angled 30°
Tip width: 0.6 mm
Tip thickness: 0.25 mm
Titanium
12.5 cm

No. 10167-11

Vessel Dilating Probe



Tip diameter: 0.6 mm
12.5 cm

No. 10160-13

Gross Anatomy Probe



MOST POPULAR

Tip diameter: 1.2 mm
15 cm

No. 10088-15

Combination Probe and Spatula

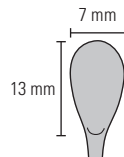

14 cm

No. 10090-13

Combination Spoon and Spatula

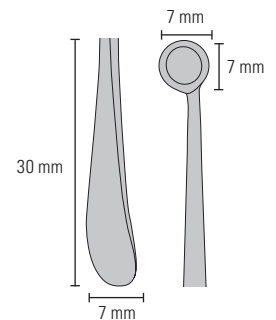

17.5 cm

No. 10090-17

Micro Spatula

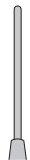

Tip width: 1 mm
Tip thickness: 0.25 mm
11 cm

No. 10089-11

**Mirror Finish
Micro Spatula**

Mirror finished to provide a non-stick spatula.



Tip width: 0.8 mm
Tip thickness: 0.25 mm
12 cm

No. 10087-12

**Double-Ended
Micro Spatula**

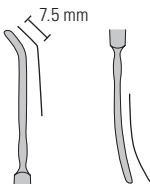

Tip width: 2 mm
Tip thickness: 0.3 mm
13 cm

No. 10091-12

**MOST
POPULAR**

Iris Spatulae



Tip width: 3 mm
Tip thickness: 0.4 mm
13 cm

No. 10094-13



Tip width: 1.7 mm
Tip thickness: 0.3 mm
13 cm

No. 10093-13



Tip width: 1.8 mm
Tip thickness: 0.3 mm
12 cm

No. 10092-12

Mini Hippocampal Dissecting Tool

The instrument ends are malleable to allow you to adjust their shape to the correct angle for optimal positioning.



14.5 cm

No. 10099-12

Hippocampal Dissecting Tool

The instrument ends are malleable to allow you to adjust their shape to the correct angle for optimal positioning.



16 cm

No. 10099-15

Pin Holder

Light weight.



Nickel-plated chuck
Aluminum handle
Jaw opening: 0–1 mm
17 cm

No. 26018-17

Pin Holder



Moria

**MOST
POPULAR**

Nickel-plated
Jaw opening: 0–1 mm
12 cm

No. 26016-12

Self Holding Pin and Bone Screw Forceps

Designed with a serrated tip and grooved cup for a stable and secure grip, these forceps hold pins and screws allowing precise placement at your target area. They are compatible with all Fine Science Tools insect pins, minutien pins and bone screws.



Polished stainless steel
14 cm

No. 26100-00

Insert Pins

All insert pins fit any of our pin holders. Pins are antimagnetic and acid resistant.

Stainless steel
5 cm



No. 26007-01 -02 -03 -04 -05

Black Anodized Minutien Pins

These high quality pins are black for best visibility under high magnification and bright light.

Tip diameter: 0.0175 mm
Rod diameter: 0.15 mm
10 mm

Box of 500 pins
No. 26002-15



Stainless Steel Minutien Pins

The thinnest and finest pins available.

Tip diameter: 0.0125 mm
Rod diameter: 0.1 mm
10 mm

Box of 500 pins
No. 26002-10



Tip diameter: 0.02 mm
Rod diameter: 0.2 mm
10 mm

Box of 500 pins
No. 26002-20

Black Anodized Insect Pins

Nylon heads
Tip diameter: 0.03 mm

Pkg. of 100 pins

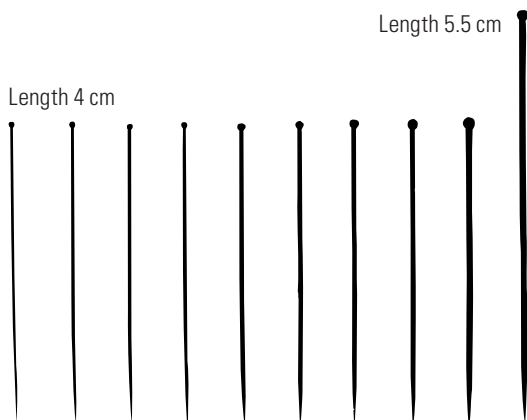

Size	000	00	0	1	2	3	4	5	6	7
Rod diameter (mm)	.25	.30	.35	.40	.45	.50	.55	.60	.65	.70
No. 26000	-25	-30	-35	-40	-45	-50	-55	-60	-65	-70

Stainless Steel Insect Pins

Nylon heads
Tip diameter: 0.03 mm

Pkg. of 100 pins

Size	000	00	0	1	2	3	4	5	6	7
Rod diameter (mm)	.25	.30	.35	.40	.45	.50	.55	.60	.65	.70
No. 26001	-25	-30	-35	-40	-45	-50	-55	-60	-65	-70

Etched Tungsten Micro Needles

These tungsten micro needles are drawn to a 1 micron tip and three different rod diameters are offered. Each provides lateral stability as well as minimal spring action during manipulation. The micro needles can be used with our pin holders shown on page 106.

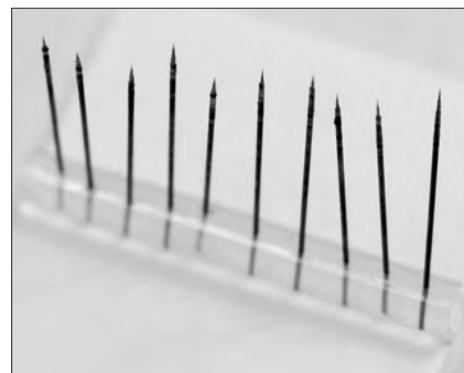

Tip diameter: 1 µm (0.001 mm)
12 mm

Box of 10 needles

Rod diameter (mm)	Item	Price
0.125	No. 10130-05	
0.25	No. 10130-10	
0.5	No. 10130-20	

Spoon



Diameter: 8 mm
Depth: 2 mm
12.5 cm

Moria 1121B
No. 10321-08

Mini Perforated Spoon

Most commonly used to take embryos out of solution and handling very small organs.



Perforations are
0.8 mm in diameter.

Diameter: 8 mm
Depth: 1 mm
10 cm

Moria MC 17C
No. 10370-19

Perforated Spoon

Most commonly used to take embryos out of solution and handling very small organs.

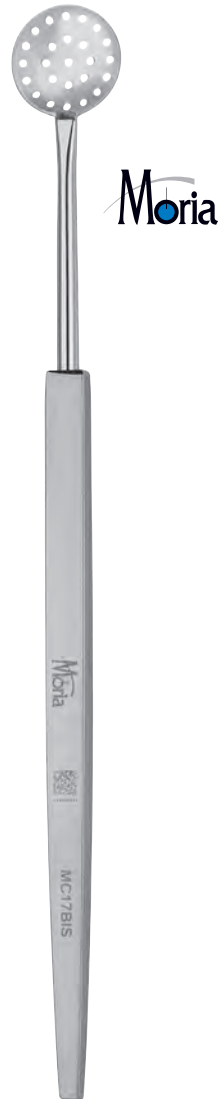

Perforations are
0.9 mm in diameter.

MOST POPULAR

Diameter: 15 mm
Depth: 3 mm
14.5 cm

Moria MC 17 BIS
No. 10370-18

Diameter: 20 mm
Depth: 5 mm
14.5 cm

Moria MC 17
No. 10370-17

Mirror Finish Cutting Spoon

Non stick cutting spoon.



Diameter: 4.5 mm
Depth: 0.15 mm
13 cm

No. 10360-13

Featured Products Online

Our Featured Products are available in limited quantities, for a limited time while supplies last. Please visit our website, **finescience.com** for updates on what's new and currently available.

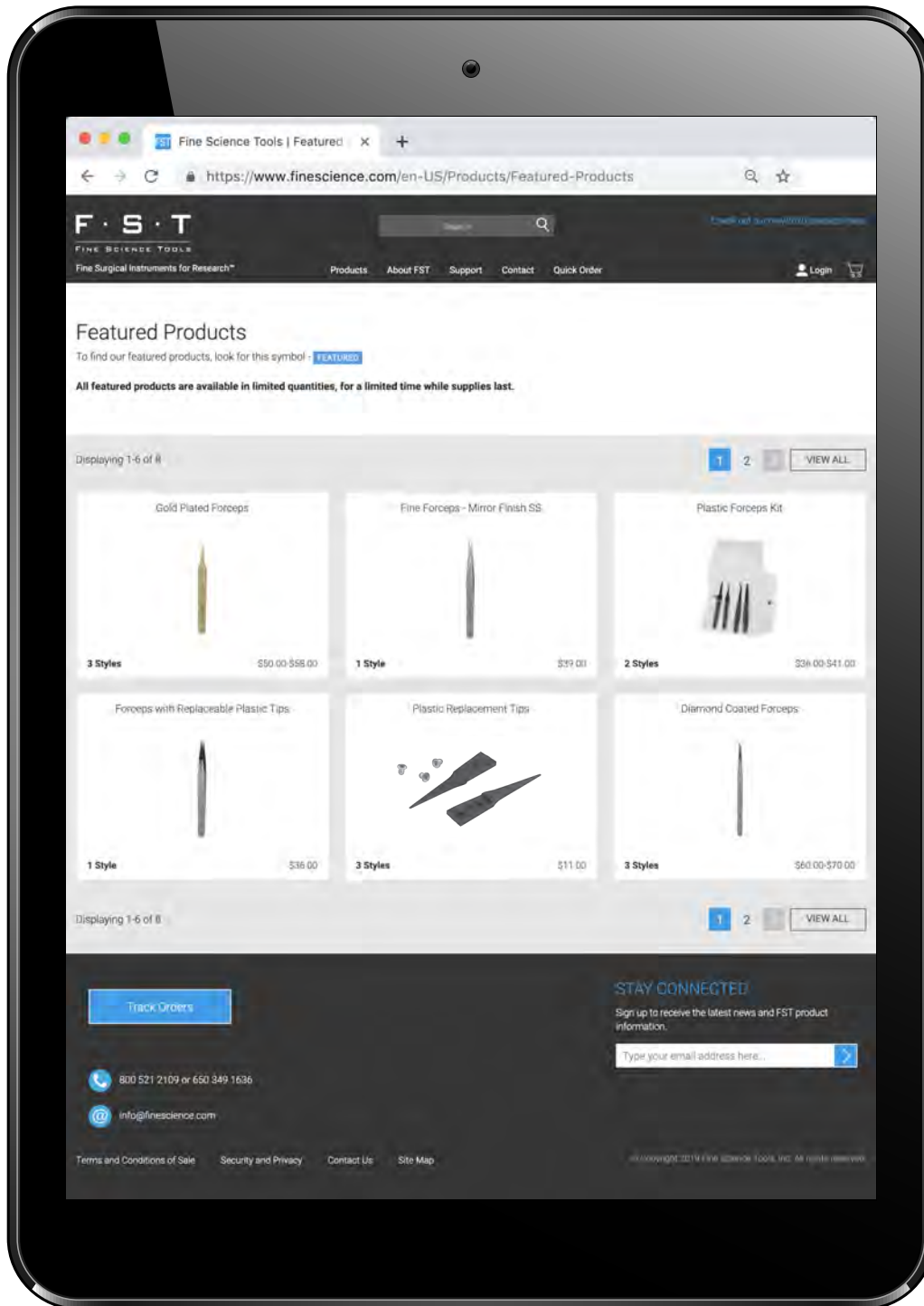

FEATURED PRODUCTS

Castroviejo

Micro pattern, with slightly blunted tips.



Straight
9 cm

With lock
No. 12060-01

Without lock
No. 12060-02



Curved
9 cm

With lock
No. 12061-01

Without lock
No. 12061-02

Needle Holder with Suture Cutter



Curved
Cutting edge: 3.5 mm
14 cm

Without lock
No. 12075-14

Cautionary note:

Never use a micro needle holder with needles that are too thick, as this can easily damage the fine jaws. Use only micro needles of less than 0.2 mm diameter (see page 116).

Round Handled Needle Holder

Round handles allow easy fingertip adjustments.



Straight
12.5 cm

With lock
No. 12075-12

Without lock
No. 12076-12

Mathieu

Extra slim and narrow profile, with squeeze-lock.
Facilitates excellent wrist motion for suturing.

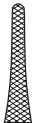

14 cm
With lock
No. 12010-14



With tungsten carbide jaws
14 cm
With lock
No. 12510-14



For more information see page 183.

Castroviejo with Tungsten Carbide Jaws

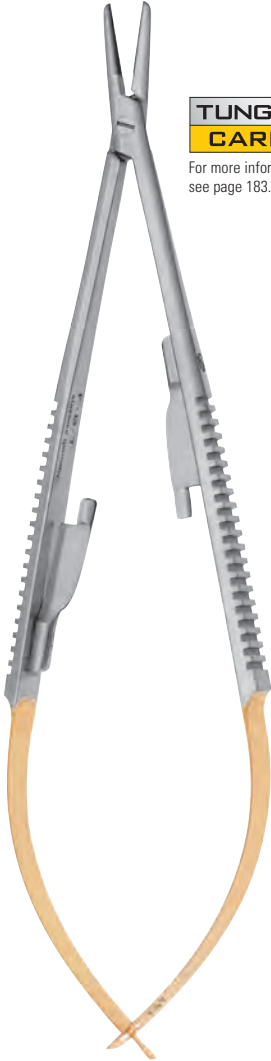

For more information see page 183.



With tungsten carbide jaws
14 cm
With lock
No. 12565-14

NEEDLE HOLDERS

Halsey



Smooth
13 cm

No. 12001-13



With tungsten
carbide jaws
13 cm

No. 12501-13

**TUNGSTEN
CARBIDE**

For more information
see page 183.

Halsey with Tungsten Carbide Jaws



**TUNGSTEN
CARBIDE**

For more information
see page 183.



With tungsten
carbide jaws
12.5 cm

No. 12500-12

Olsen-Hegar with Suture Cutter



10 mm cutting edge
1.5 mm jaw surface
12 cm



15 mm cutting edge
2 mm jaw surface
14 cm

MOST POPULAR

No. 12002-12

No. 12002-14



No. 12102-12

Olsen-Hegar with Suture Cutter and Tungsten Carbide Jaws



TUNGSTEN CARBIDE

For more information see page 183.



With tungsten carbide jaws
10 mm cutting edge
1.5 mm jaw surface
12 cm



With tungsten carbide jaws
15 mm cutting edge
2 mm jaw surface
14 cm

No. 12502-12

No. 12502-14



No. 12512-12

NEEDLE HOLDERS

Crile-Wood



15 cm

No. 12003-15



With tungsten carbide jaws
15 cm

No. 12503-15

**TUNGSTEN
CARBIDE**

For more information
see page 183.



No. 12504-15

Mayo-Hegar



16 cm

No. 12004-16

18 cm

No. 12004-18

**Slim Elongated Needle Holder
with Tungsten Carbide Jaws**

Ryder Mini-Select Needle Holder

This needle holder has been uniquely fashioned with tungsten carbide dust tips, giving the clamping platform an extra secure grip.



Side View



With tungsten
carbide jaws
15 cm

No. 12005-15



With tungsten
carbide dust tips
15 cm

No. 12505-15

Microsurgical Needles with Suture Thread Attached

The combination of proprietary needle design technology and state-of-the-art manufacturing techniques has enabled S&T to provide a microsurgical needle that is unmatched in the industry. S&T microsurgical needles provide frictionless tissue penetration. They are inspected under the microscope at critical stages during the manufacturing process, and a multi-point final inspection of each suture and needle combination ensures a high quality product. The suture-to-needle attachment is tested to higher standards than the USP specifications.

Features:

- Needle and thread combination comprising of non-absorbable black nylon polyamide monofilament thread and stainless steel 3/8 circle needle. Nylon is suitable for closing ophthalmic, neurological and microvascular wounds.
- 3/8 circle precision taper point. Stainless steel needle honed under microscope by hand. Superfine round tip with flattened body to improve stability in needle holder. Easy penetration. Precise stitch placement.
- Grinding geometry and suture needle attachment are directed toward frictionless tissue penetration.
- Each needle suture combination is individually packed and sealed in a peel-open blister pack.

Sterile

Pkg. of 12 disposable units



400% of actual size

No. 12051-11



No. 12051-10



No. 12051-09



No. 12051-08

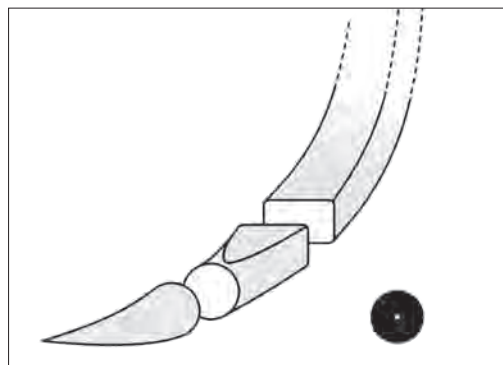

Standard taper point needle



Suture size	Suture length (cm)	Needle diameter (micron)	Needle diameter (mm)	Needle chord length (mm)	Circle	Arch (mm)	Item	Price
11/0	10	50	0.05	3	3/8	3.8	No. 12051-11	
10/0	10	70	0.07	3	3/8	3.8	No. 12051-10	
9/0	15	100	0.1	4	3/8	5.1	No. 12051-09	
8/0	15	140	0.14	5	3/8	6.4	No. 12051-08	

Suture Needles

Polished stainless steel
3/8 curved
Round with standard eye
Diameter 0.35 mm

Non-sterile

Pkg. of 12 needles

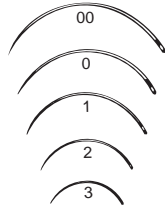

Size	Item	Price
00	No. 12050-20	
0	No. 12050-10	
1	No. 12050-01	
2	No. 12050-02	
3	No. 12050-03	

Silk Suture

Silk suture has a smooth flow through tissue while maintaining knot security.

Braided silk

Non-sterile



Size	Diameter (mm)	Spool length (m)	Item	Price
7/0	0.05	91	No. 18020-70	
6/0	0.08	23	No. 18020-60	
5/0	0.12	23	No. 18020-50	
4/0	0.17	23	No. 18020-40	
3/0	0.22	23	No. 18020-30	
2/0	0.32	23	No. 18020-20	
0	0.37	23	No. 18020-00	
1	0.45	23	No. 18020-01	
2	0.55	23	No. 18020-02	
3	0.65	23	No. 18020-03	

For Suture Tying Forceps, see pages 76 and 77.

Nylon Monofilament Suture

Nylon is known for its uniform diameter flexibility and outstanding consistent knot security.

Nylon monofilament

Non-sterile



Size	Diameter (mm)	Spool length (m)	Item	Price
8/0	0.04	91	No. 18030-80	
7/0	0.05	91	No. 18030-70	
6/0	0.07	91	No. 18030-60	
5/0	0.10	91	No. 18030-50	
4/0	0.15	91	No. 18030-40	
3/0	0.20	91	No. 18030-30	

Suturing Principles and Techniques in Laboratory Animals

Introduces the basic principles, materials and surgical instruments required for suturing and wound closure used on animals. The manual provides descriptions and pictures portraying proper tissue handling and aseptic technique, correct hand placement and use of surgical instruments, proper needle placement on needle holders, and provides an in-depth explanation of various suture patterns and associated principles for proper knot tying during wound closure. The DVD provides descriptive narrative and step-by-step video demonstrations for each of the suturing techniques.

Manual and DVD



Includes: Fine Science Tools Item Number Reference Page for all surgical instruments used in the manual.

No. 23005-10

SUTURE BOOK/DVD

Michel Suture Clips

Anti-magnetic, acid-resistant stainless steel
Pkg. of 1,000 clips

Size (mm)	Item	Price
7.5 x 1.75	No. 12040-01	
11 x 2	No. 12040-02	
12 x 2.5	No. 12040-03	

Larger clip sizes also available.

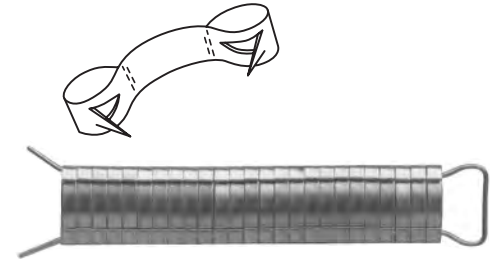

Applying Forceps



For all Michel suture clips
12.5 cm

No. 12018-12

Applying and Removing Instruments



For clip sizes 12040-02 and larger
Curved
13 cm

No. 12028-12



For clip size 12040-01 only
Angled
13 cm

No. 12029-12

Reloadable Skin Stapler with Rotating Head

The 360° degree swivel nose and unique design offers maximum visibility at the delivery point. The stainless steel staples are non-sterile and feature the patented "Twin Towers" staple design which make for quick and easy removal. The disposable staple cartridge includes a printed staple counter. **The handle is reusable and autoclavable. Staples are non-sterile. Components sold separately or as a kit.**

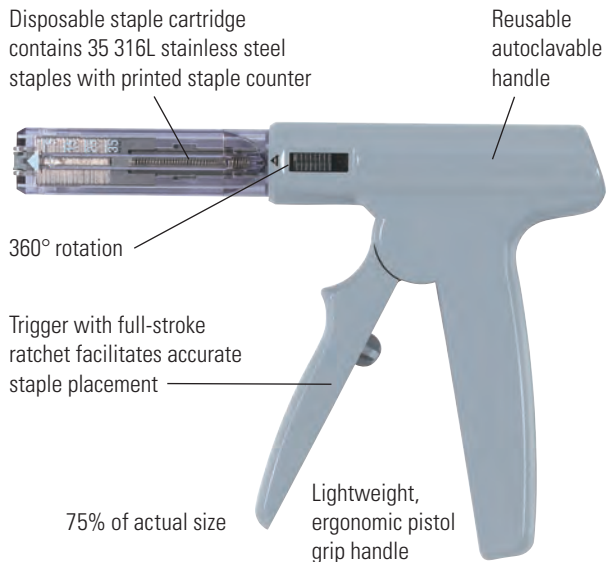

Surgical staple kit
 • 1 Handle
 • 1 Remover
 • 12 Disposable staple cartridges
 No. 12030-20

Single disposable cartridge
 35 staples per cartridge
 No. 12030-22

12 disposable cartridges
 35 staples per cartridge
 No. 12030-23

Handle
 No. 12030-01

Surgical Staple Remover

Compatible with Reloadable Skin Stapler with Rotating Head and Manipler® Skin Stapler.



10 cm
 No. 12030-04

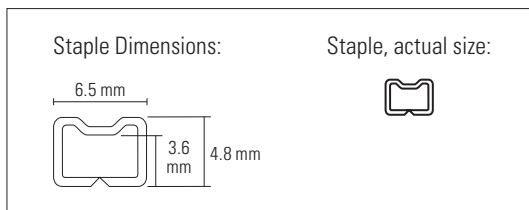

SKIN STAPLERS

Manipler® Skin Stapler

Quality, slim, lightweight design with consistent actuation and staple count indicator. **Disposable, sterile, and not autoclavable.**

15 cm
 35 staples per cartridge
 No. 12035-00

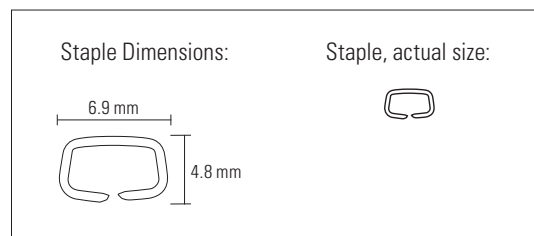

AutoClip® System

The AutoClip® System is a safe, secure method of wound closure. Faster and easier than suture, this system is perfect when staples may be too thin to provide adequate closure. **Non-sterile and not autoclavable. Components sold separately or as a kit.**



Applier



Clips



Remover

AUTOCLIP SYSTEM

- AutoClip® Kit
- 1 Applier
 - 9 mm clips (100)
 - 1 Remover
 - Storage case

No. 12020-00

AutoClip® applier
11.5 cm

No. 12020-09

AutoClip® 9 mm clips
Pkg. of 100 clips

No. 12022-09

AutoClip® remover
12.5 cm

No. 12023-00

Guthrie

Extra delicate pattern.

2.5 mm



2 Pronged
Blunt
13 cm
No. 17021-13

6 mm



2 Pronged
Blunt
13.5 cm
No. 17023-13

Blair

6 mm



4 Pronged
Blunt
13.5 cm
No. 17022-13

Fomon

13 mm



2 Pronged
2 mm Ball at each tip
17 cm
No. 17020-17

Slide Retractor with Blades



Maximum spread: 1 cm
Atraumatic blades
2 cm

No. 17004-03

Mini-Goldstein

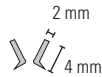

Maximum spread: 0.5 cm
3x3 Sharp teeth
2 cm

No. 17002-02

Mini-Colibri



Maximum spread: 1 cm
2 cm

No. 17000-01

RETRACTORS

Slide Retractor with Teeth



Maximum spread: 1 cm
2x2 Blunt teeth
2 cm

No. 17005-03

Goldstein

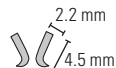

Maximum spread: 1.8 cm
3x3 Sharp teeth
3 cm

No. 17003-03

Colibri



Maximum spread: 1.5 cm

3 cm
No. 17000-03

4 cm
No. 17000-04

MOST POPULAR



Maximum spread: 1.2 cm

3 cm
No. 17000-02

Fine Adjustable
Wire Retractor



Maximum spread: 3.5 cm
Thin, curved blades
5 cm

No. 17004-05

Agricola

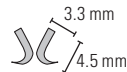

Maximum spread: 3.5 cm
3x3 Sharp teeth
4 cm

No. 17005-04

Speculum

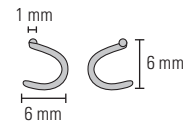

Maximum spread: 3.5 cm
Thin, curved blades and grooved finger grips
4.5 cm

Moria 7699
No. 17370-53

Alm Retractor with Wire Teeth

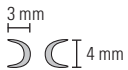

Maximum spread: 4 cm
 Arms gently curved down
 7 cm

No. 17010-07

Alm Retractor with Blunt Teeth



Maximum spread: 4 cm
 Arms gently curved down
 7 cm

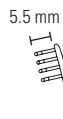

Blunt teeth
 No. 17008-07

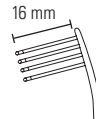

Long blunt teeth
 No. 17009-07

Alm Retractor with Blades

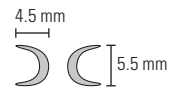

Maximum spread: 4.5 cm
 Arms gently curved down
 Thin, curved blades
 7.5 cm

No. 17009-08

Spring-Loaded Retractor



Curved atraumatic blades

Maximum spread: 3 cm
Blade dimensions: 14 x 10 mm
5.5 cm

No. 17006-05

Maximum spread: 4 cm
Blade dimensions: 22 x 16 mm
8 cm

No. 17007-08

Bowman



Maximum spread: 2.5 cm
8 cm

No. 17001-07

Heiss

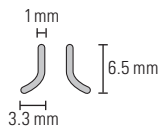

Maximum spread: 2.3 cm
 4x4 Blunt teeth
 10 cm

No. 17011-10

Gelpi



Maximum spread: 3 cm
 Angled down
 1x1 Sharp teeth
 10 cm

No. 17017-10

Weitlaner-Locktite

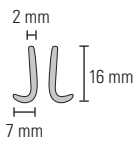
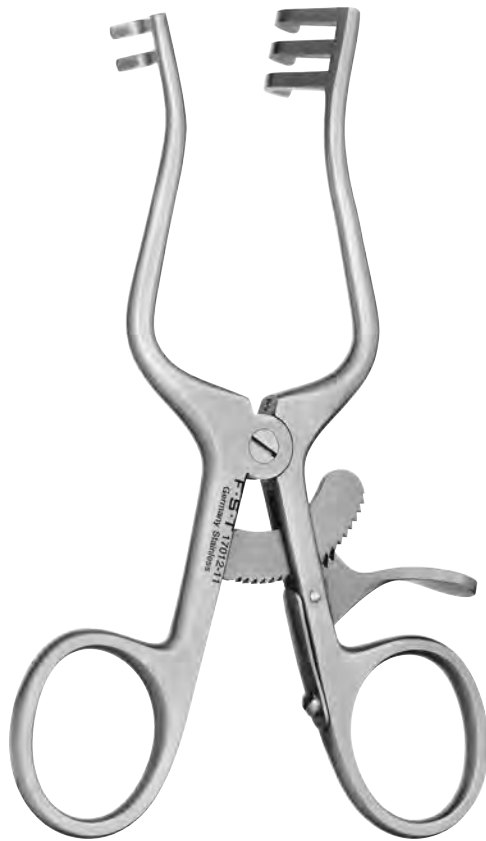

Maximum spread: 4.5 cm
 2x3 Blunt teeth
 11 cm
 No. 17012-11

Maximum spread: 6.5 cm
 3x4 Blunt teeth
 13 cm
 No. 17012-13

Wullstein

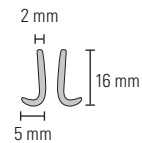

Maximum spread: 4.5 cm
 Angled down
 3x3 Blunt teeth
 11 cm

No. 17018-11

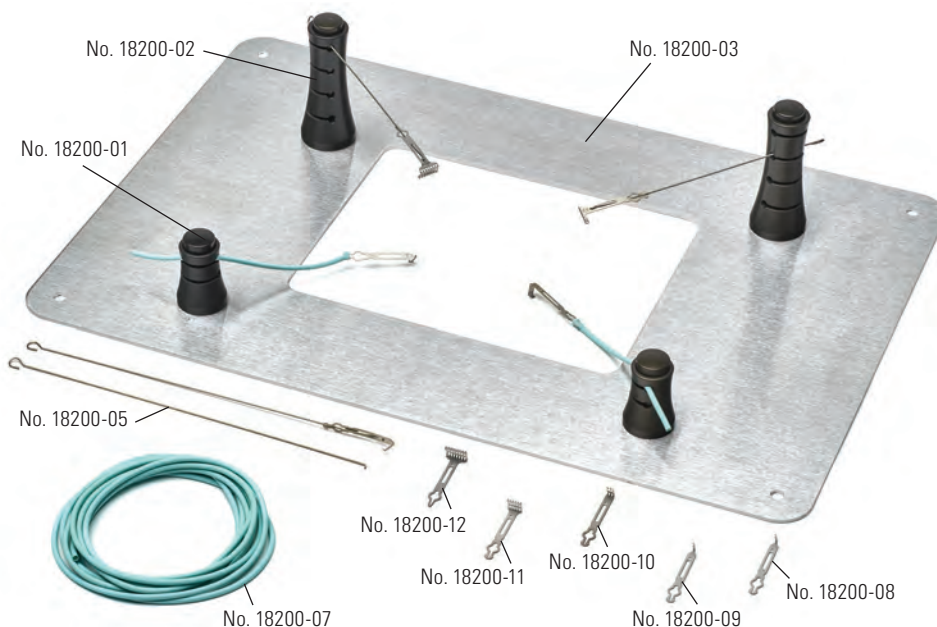

Magnetic Fixator Retraction System

This Small Animal Retraction System simplifies set-up procedure and provides the examiner with an excellent overview of the operative site. It consists of three components: Base Plate (Nos. 18200-03 & 18200-04); Fixators (Nos. 18200-01 & 18200-02); and Retractors (Nos. 18200-05 through 18200-12).

The Base Plates are made from magnetic stainless steel and are available in two sizes. The surface is nonreflective and both plates have a window in the center which allows the animal contact with body temperature control systems. The window sizes are 10 x 13 cm for the small base plate and 15 x 25 cm for the large.

The Fixators are movable anchors made from anodized aluminum with a surgical grade rare earth magnet in the base for attachment anywhere on the Base Plate. The magnets do not interfere with lab electronics and can be used in close proximity (3 cm) to ferro-magnetic items. They incorporate pushbutton-activated spring locks that grip either the Wire or Elastomer Retractors.

The Retractors are interchangeable Retractor Tips (Nos. 18200-08 through 18200-12) which attach to either Retractor Wire (Nos. 18200-05 & 18200-06) for static retraction or to Elastomer (No. 18200-07) for dynamic retraction. The Retractor Tips are light and atraumatic to delicate tissue or membrane.

All system components are autoclavable.

Kit for animals up to 200 g

Includes:

- 1 Small base plate (No. 18200-03)
- 2 Short fixators (No. 18200-01)
- 1 Tall fixator (No. 18200-02)
- 1 Elastomer, 2 m roll (No. 18200-07)
- 1 Package of retractors, blunt, 1 mm wide (No. 18200-09)
- 1 Package of retractors, blunt, 2.5 mm wide (No. 18200-10)

No substitutions

No. 18200-20

Kit for animals from 200 g up to 5 kg

Includes:

- 1 Large base plate (No. 18200-04)
- 2 Short fixators (No. 18200-01)
- 2 Tall fixators (No. 18200-02)
- 1 Elastomer, 2 m roll (No. 18200-07)
- 1 Package of retractors, blunt, 2.5 mm wide (No. 18200-10)
- 1 Package of retractors, blunt, 5 mm wide (No. 18200-11)

No substitutions

No. 18200-50

Individual parts:

Short fixator, 2.5 cm high
Each
No. 18200-01

Tall fixator, 5 cm high
Each
No. 18200-02

Small base plate, (20 x 30 cm)
Each
No. 18200-03

Large base plate, (25 x 35 cm)
Each
No. 18200-04

Wire handles, 10 cm long
Pkg. of 10
No. 18200-05

Wire handles, 14 cm long
Pkg. of 10
No. 18200-06

Elastomer, 2 m roll
No. 18200-07

Sharp retractors
Pkg. of 10
No. 18200-08

Blunt retractors, 1 mm wide
Pkg. of 10
No. 18200-09

Blunt retractors, 2.5 mm wide
Pkg. of 10
No. 18200-10

Blunt retractors, 5 mm wide
Pkg. of 10
No. 18200-11

Blunt retractors, 7.5 mm wide
Pkg. of 10
No. 18200-12

Clamp Size and Clamp Pressure

Clamp pressure is determined by the closing force of the clamp (in grams), divided by the area of the vessel wall that is compressed between the jaws (in square millimeters). Thus, the smaller the vessel, the higher the pressure exerted.

Despite the wide range of closing forces, the pressure exerted by each clamp, big or small, remains consistent throughout the series. Each size of clamp exerts a pressure of 5g/mm² when used on the largest vessel in its range, and 15g/mm² when used on the smallest vessel. Even at the higher range, S&T's micro clamps have the gentlest working pressure of any small vessel clamp available.

Clamp (ea)	L x W (mm)	Vessel Diameter Range (mm)
00396-01 & 18040-11	3.5 x 1.0	0.4 - 1.0 ◦ ◦
00398-02 & 18040-22	5.5 x 1.5	0.6 - 1.5 ◦ ◦
00400-03 & 18040-33	7.5 x 1.75	1.0 - 2.25 ◦ ◯
00325-00	10 x 2.15	2.0 - 5.0 ◦ ◯

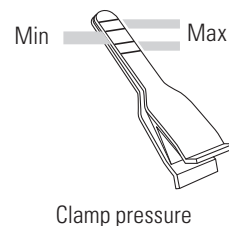
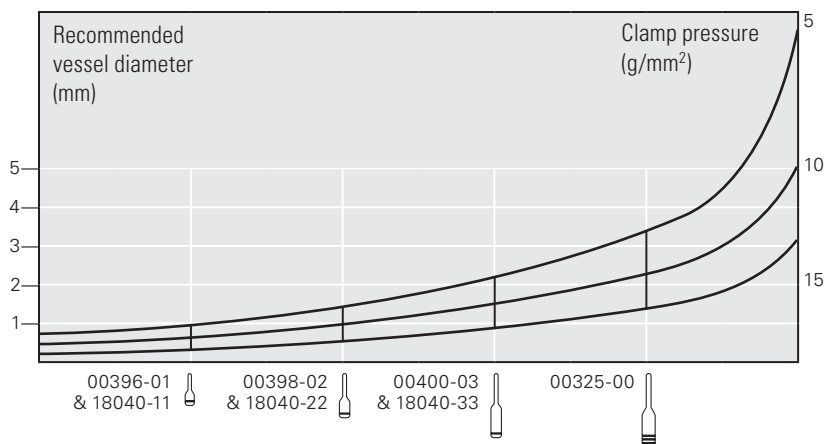

See page 131 for Micro Clamp and Double Clamp Appliers.

MICRO CLAMPS

Micro Clamps S&T®



S&T B-1
No. 00396-01



S&T B-2
No. 00398-02



S&T B-3
No. 00400-03



S&T HD-S
No. 00325-00

Double Micro Clamps

For vascular approximation at anastomosis. These clamps are mounted on a 10 mm sliding bar and can easily be moved by applying gentle force. The distance between the jaws of the clamps is adjustable from 3 to 16 mm.



No. 18040-11



No. 18040-22



No. 18040-33

Micro Clamp Applying Forceps



S&T[®]

Only compatible with
S&T Micro Clamps
14 cm

With lock
No. 00071-14

Without lock
No. 00072-14

Micro Clamp Applying Forceps

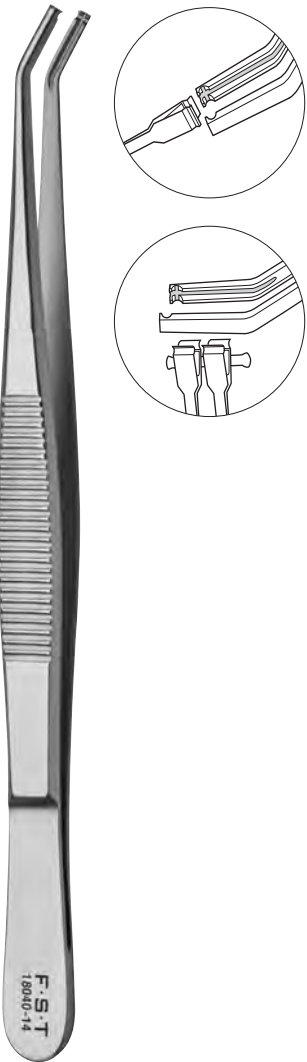

Compatible with S&T
Micro Clamps and
Double Micro Clamps
14.5 cm

No. 18040-14

Micro Clip Applicator with Lock



For use with our 18055 series micro serrefines 14 cm

No. 18056-14

Forceps Style Clip Applicator

This applicator features special U-shaped side supports for improved seating of the clips.



For use with our 18055 series micro serrefines 14 cm

No. 18057-14

Stainless Steel Micro Serrefines

Used to obtain a clear surgical field for extended arterial cross-clamping.

Delicate atraumatic serrations
Spring width: 2 mm



	No. 18055-01	-02	-03	-04
Jaw length (mm)	10	8	6	4
Jaw width (mm)	2	2	1	0.75
Total length (mm)	19	16	15	13
Jaw pressure (g)	60	85	100	125



	No. 18055-05	-06
Jaw length (mm)	6	4
Jaw width (mm)	1	0.75
Total length (mm)	17	16
Jaw pressure (g)	100	125

Titanium Micro Serrefines

TITANIUM

Lightweight with strong clamping pressure.

For more information see page 183.

Delicate atraumatic serrations
Spring width: 2 mm



	No. 18555-01	-02	-03	-04
Jaw length (mm)	10	8	6	4
Jaw width (mm)	2	2	1	0.75
Total length (mm)	19	16	15	13
Jaw pressure (g)	60	85	100	125

Cautionary note: Micro Serrefines should never be compressed with fingers; use only the appropriate applicator No. 18056-14 or No. 18057-14.

Moria Vessel Clamp

Finely serrated (atraumatic)
 Light pressure
 For vessels up to 2 mm in diameter
 Calibrated to 15g/mm²
 1.8 mm wide, 3 cm long
 Straight
 33 mm



Moria 201/A
 No. 18320-11



Dietrich Bulldog Clamps

Serrated
 Good access to deep seated vessels
 Closing pressure: 50 g (light)
 Weight: 3 g



Straight
 52.5 mm
 No. 18038-45



Angled
 50 mm
 No. 18039-45

Schwartz Micro Serrefines

Non-serrated
 Strong pressure
 26 mm

MOST POPULAR

Straight
 No. 18052-01



Light bend
 No. 18052-02



Sharp bend
 No. 18052-03



Moria Bulldog Type Clamps

Non-serrated
 Strong pressure
 2 mm wide
 53 mm



Straight
 Moria MC43
 No. 18374-43



Curved
 Moria MC44
 No. 18374-44



Bulldog Type Serrefines

Serrated

Straight
 Medium pressure
 28 mm
 No. 18050-28



Curved
 Medium pressure
 28 mm
 No. 18051-28



Straight
 Strong pressure
 35 mm
 No. 18050-35



Straight
 Strong pressure
 50 mm
 No. 18050-50



Curved
 Strong pressure
 35 mm
 No. 18051-35

Curved
 Strong pressure
 50 mm
 No. 18051-50

Mini Serrefines

Smallest bulldog-type hemostatic clamps
 Medium pressure
 Gentle serrations
 2 mm wide
 28 mm

Straight
 No. 18054-28



Curved
 No. 18053-28



Bulldog Artery Spring Clamp

Can be used with a minimum of distortion for MRI investigations.

Straight
 Serrated
 Light pressure
 30 mm



TITANIUM For more information see page 183.

No. 18144-30



Silver Neuro Clips

These single-use, silver neuro clips are meant for permanent vessel occlusion.

Pkg. of 100 clips
No. 18040-00

Vascular Occluders

Applications

- Fast, dependable zero-flow baseline determination in blood flow studies.
- Partial to full occlusion of vessels for circulation research studies.
- Prolonged implantations, such as chronic blood flow studies.
- Constriction of soft organs in acute or chronic applications.

Operation

Step 1 Apply the occluder cuff around the exposed blood vessel. Secure it in place with suture material through the eyelets.

Step 2 Occlude the vessel to the desired degree by inflating the diaphragm with air or liquid injected into the actuating tube using a syringe and blunt needle. Clamp the tubing to maintain occlusion of the vessel over time.

Step 3 To deflate, simply withdraw the air or liquid.

Benefits

- Occlusion is accomplished without traction on vessels or surrounding tissues.
- The actuating tube may be exteriorized from the occlusion site for remote actuation.
- Performance during implantations is reliable and consistent.
- Autoclavable or cold sterilized, and easily maintained.
- Made from soft, flexible 100% silicone rubber.
- Fully operational with instant response using air, liquids, or inert gases.

Selection

The lumen diameter when deflated is usually the determining factor in the selection of the proper device. Select the occluder size that provides a slightly loose fit around the subject vessel. The cuff width and thickness will vary, depending on models and sizes.

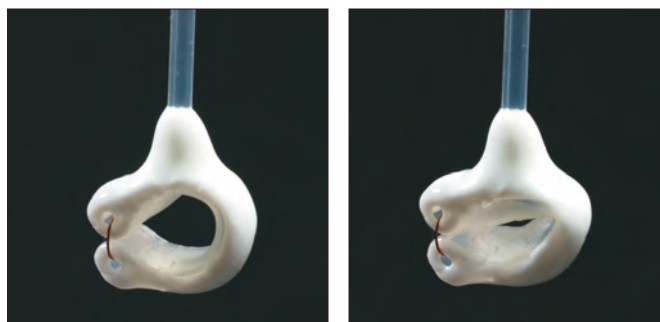

The actuating tube length is 90 cm and measures 0.76 mm ID x 1.6 mm OD. Detailed instructions are included.

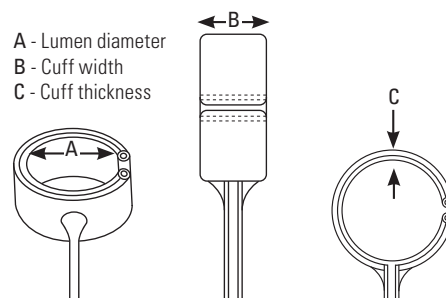

VO-1.5 N

Lumen diameter: 1.5 mm
Cuff width: <3.5 mm
Cuff thickness: 1.5 mm

No. 18080-01

VO-2

Lumen diameter: 2 mm
Cuff width: 5 mm
Cuff thickness: 1.5 mm

No. 18080-02

VO-3

Lumen diameter: 3 mm
Cuff width: 5 mm
Cuff thickness: 1.5 mm

No. 18080-03

V-Hook

Aids in feeding fine suture around blood vessels, works very similar to ligation aids.



400%

Tip diameter: 0.4 x 0.2 mm
11 cm

No. 18052-12

Ligation Aids

A handy instrument for leading a fine suture under and around a blood vessel for tying-off purposes. Also useful for ligating peripheral nerves. Grooves toward hole help threading.



150%

Ultrafine
Hole diameter: 0.4 mm
10.5 cm

No. 18062-12



175%

Hole diameter: 1 mm
13.5 cm

No. 18062-13



150%



Hole diameter: 1 mm
13.5 cm

No. 18063-13

Vessel Dilators

Highly modified forceps with elongated, parallel tips which are highly polished. Designed for controlled intraluminal vessel dilation.

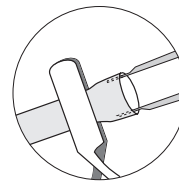

DILATORS



Angled 10°
11 cm

Tip diameter: 0.1 mm
No. 00126-11

Tip diameter: 0.2 mm
No. 00125-11



Angled 45°
Tip diameter: 0.2 mm
13.5 cm

No. 00276-13



Angled 10°
12 cm

Tip diameter: 0.1 mm
No. 18131-12

Tip diameter: 0.2 mm
No. 18132-12

Tip diameter: 0.3 mm
No. 18133-12

Balanced Instruments

Balanced instruments are designed to put the center of gravity between the thumb and index finger. This is accomplished by adding a slight counter weight to the proximal end of the instruments. The design enhances tactile feel, aiding in better control and precision.

Vessel Dilators

The tips of these multipurpose forceps are configured to enable their use as dilators at the front, as well as needle holders and tying forceps further in the back. The platform at the tips close parallel ensuring a reliable grip.

Vessel Dilator



86% of actual size



Straight
Suture tying platform
Tip diameter: 0.1 mm
14.5 cm

No. 18601-15



86% of actual size



Straight
Suture tying platform
Tip diameter: 0.3 mm
15 cm

No. 18602-15



86% of actual size



Angled
Smooth
Tip diameter: 0.2 mm
14.5 cm

No. 18603-14

Micro Cannulation System

This micro cannula is most helpful for quick and easy insertion in arteries and veins. It can be used as an “indwelling” catheter during long term experiments. With care, thorough rinsing and sterilization, it can be reused several times. Detailed instructions are included.



Features

- Biocompatible Teflon® tubing.
- Cannula size 0.33 mm OD – 0.16 mm ID
- A pointed stainless steel stylus (trocar), to aid in vascular penetration and allow a maximum range of cannula manipulation during insertion.
- Contoured tip for easy insertion, fitted with shoulder for “tie-in” to prevent accidental removal.
- Female luer connection for linkage to infusion lines.

8 cm
No. 18000-10

CANNULATION

1 Approach
Cannulation Forceps (Item No. 18403-11) and Spinal Cord Hook (Item No. 10162-12) aid in the insertion process.

2 Insertion
Remove trocar and advance cannula.

3 Secure
Use shoulder hub and suture to “tie in” cannula to prevent accidental removal.

Instruments sold separately.

Vessel Cannulation Forceps

These vessel cannulation forceps are useful whenever a fine plastic tube has to be introduced into a small blood vessel of almost equal size. The hollowed jaws hold the tubing securely without deforming it. The tip of the tubing is directed exactly into the vessel opening without damage to the vessel from unwanted movement.

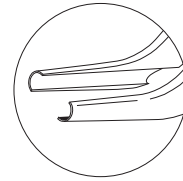

S&T®



DUMONT
S W I S S M A D E



CANNULATION

For tubing between
0.5 and 1 mm OD
11 cm

No. 00574-11

For tubing of 0.35 mm OD
11 cm
No. 11280-11

For tubing of 0.5 mm OD
11 cm
No. 11281-11

For tubing of 1 mm OD
11 cm
No. 11282-11

For tubing of 0.35 mm OD
11.5 cm
No. 18403-11

For tubing of 0.6 mm OD
11.5 cm
No. 18406-11

For tubing of 0.6 mm OD
13.5 cm
No. 18406-13

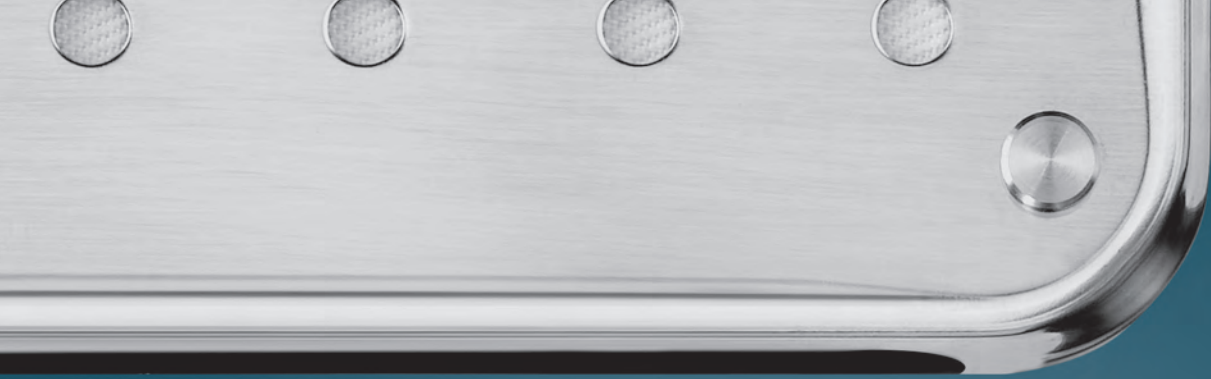

Surgical & Laboratory Accessories

Animal Accessories	Pages	141 – 143
Instrument Care & Accessories	Pages	144 – 155
Surgical Accessories	Pages	156 – 159
Laboratory Accessories	Pages	160 – 171



Reusable Gavage Feeding Needles

Stainless steel feeding needles with luer lock hub. Also ideal for transcardiac perfusions with a fixative.

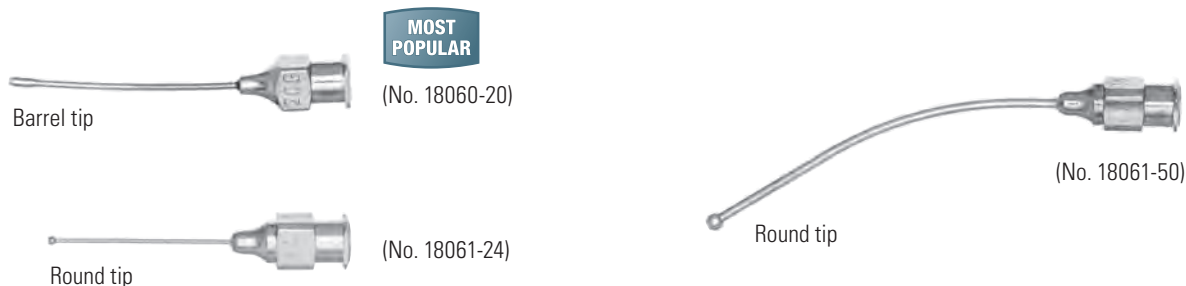

Gauge	Length (mm)	Tip diameter (mm)	Shape	Mice	Rats	Guinea pigs	Item	Price
24	25	1.25	Straight	>14 g			No. 18061-24	
22	25	1.25	Straight	15-20 g			No. 18061-22	
20	30	Barrel	Straight	20-25 g		50-75 g	No. 18060-20	
20	38	2.25	Straight	20-25 g		50-75 g	No. 18064-20	
20	38	2.25	Curved	20-25 g		50-75 g	No. 18065-20	
18	38	2.25	Straight	20-30 g	100-200 g	250-300 g	No. 18061-38	
18	50	2.25	Curved	25-30 g	100-200 g	250-300 g	No. 18061-50	
16	75	3.00	Curved		150-300 g	350-450 g	No. 18061-75	
16	100	3.00	Curved		150-300 g	350-450 g	No. 18061-10	

Single Use Gavage Feeding Needles

These economical feeding needles feature plastic luer hubs with silicone tips. They are nontoxic and nonpyrogenic. Needles can be easily formed to any desired shape. **Sterile.**



Pkg. of 5 needles

Gauge	Length (mm)	Tip diameter (mm)	Shape	Mice	Rats	Guinea pigs	Item	Price
20	38	1.75	Flexible	20-25 g	50-75 g		No. 18061-20	
18	50	2.50	Flexible	25-30 g	100-200 g		No. 18061-18	
15	75	3.00	Flexible		200-350 g	400-600 g	No. 18061-15	

FEEDING

GenoPunch

The interchangeable GenoPunch aids in the fast and simple collection of the 2 mm tissue sample for DNA analysis and/or genotyping. FST Exclusive Item. **Autoclavable.**



80% of actual size

GenoPunch includes:

- 1 GenoPunch
- 1 0.5 ml tube holder
- 1 1.6 ml tube holder
- 1 Screwdriver
- 4 Screws



FST does not supply microtubes.

Stainless steel and anodized aluminum
Punch diameter: 2 mm
11.5 cm

No. 24215-02

Ear Punch

Designed to ensure a fast and clean punch, this ear punch is lightweight and fits comfortably in the palm of your hand. FST Exclusive Item. **Autoclavable.**



80% of actual size

Stainless steel and anodized aluminum
Punch diameter: 2 mm
11.5 cm

No. 24214-02

Finger Loop Ear Punch

This ear punch provides stability and control for researchers using the numbering system. The 1 mm ear punch offers greater numbering variations and/or patterns.



80% of actual size

10.5 cm

Punch diameter: 1 mm
No. 24212-01

Punch diameter: 2 mm
No. 24212-02

Self Piercing Ear Tags

Ideal for use in small animals such as mice and rats, these ear tags come numbered from 1-100 or 1-500. Silver colored tags with black numbers provide high visibility making them easy to read. Once applied, tags seal and cannot be removed, providing an easy to use, permanent identification method. These ear tags are safe for use in salt water.



Ear tags
Alloy: Monel
7.8 x 2.8 mm

Black numbers 1-100
No. 24220-10

Black numbers 1-500
No. 24220-50



Ear Tags (enlarged view)



80% of actual size

Applicator
Stainless steel
14 cm

No. 24220-00

Animal Microtattoo System

A quick, efficient and affordable method of permanently identifying laboratory animals (mice as early as 1 day old). Designed and tested by laboratory animal technicians, the system utilizes a hypodermic needle at one end of a stainless steel forceps and a small metal cup containing green tattoo paste at the other side of the forceps.

By squeezing the forceps together, the needle penetrates the toe, footpad or ear of the animal and injects a deposit of green tattoo paste into the animal. A grid location pattern provided enables a numbering system that extends over 1 million.

Use of the microtattoo system is humane and in compliance with regulatory agencies for the care and use of laboratory animals. Detailed instructions are included. **Both the microtattoo forceps and green tattoo paste are autoclavable.**

Animal microtattoo system includes:

- 1 Pair plated steel microtattoo forceps
- 1 Tube (1 oz.) of green tattoo paste
- 1 Aluminum planchette
- 2 Hypodermic needles
- 1 Plastic holding case



55% of actual size

Animal microtattoo system
13 cm

No. 24201-00



Green tattoo paste
1 oz

No. 24201-01



Silicone Seal and Lubricant

This stiff non-melting silicone base maintains its consistency from -40°C to 200°C (40°F to 392°F) with less than 2% evaporation after 24 hours of exposure to 150°C (302°F). Typical applications include lubrication of stopcock rotating parts and other lab items. Seals vacuum and low pressure systems. Compatible with glass, plastics, metals, synthetic rubber gaskets and seals. **Autoclavable.**

15 ml container
No. 29051-45

Demagnetizer

This safe and easy to operate tabletop demagnetizer has a large coil opening of 8 x 4 cm in a rigid, molded housing. Can be used to demagnetize or magnetize instruments.

12 x 5.5 x 9 cm
No. 18000-15



European version differs from photo.

Instrument Sharpening Stones

Natural Arkansas oil stones feature unequaled fineness, hardness and structural density. When used with mineral oil, they will produce a sharper cutting edge.

6 mm x 9 cm
Square stone
No. 29008-01

Triangular stone
No. 29008-12

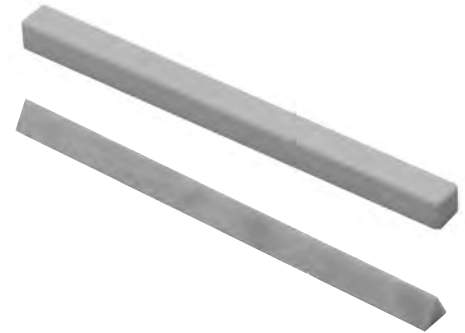

Instrument Oil and Oil Pen

Physiologically inert oil for lubricating surgical instruments, box locks, ratchets and any overlapping joints. Oil pen is refillable.

50 ml bottle
No. 29055-00



7 mm needle
12.5 cm

12 ml oil pen
No. 29055-12



Sharpening Stone for Fine Forceps

This natural Arkansas stone assists in reshaping the tips of fine forceps. The stone has two grooves, 0.8 mm and 1.6 mm, and comes in a cedar box with ten O-rings.

4 x 1 x 10 cm

No. 29008-22



Fine Forceps Repair Kit

Realign and repair fine forceps with this convenient kit. Bent forceps tips can be restraightened with the chain nose pliers. The sharpening stone has two grooves, 1.6 mm and 0.8 mm, to assist in reshaping the forceps tips. O-rings clamp the forceps shut to ensure that both shanks are equally aligned and sharpened. Instrument oil assists in producing a smooth sharp edge. Detailed instructions are included.

Kit includes:

- 1 Sharpening stone for fine forceps with ten O-rings (No. 29008-22)
- 1 Instrument oil, 50 ml bottle (No. 29055-00)
- 1 Chain nose pliers

No. 29000-00

MOST POPULAR

Optical Cleaning Kit and Lens Paper

This convenient kit contains everything you need to clean lens surfaces safely. Perfect for microscopes, camera lenses, binoculars, telescopes, graphic art optics, and all other fragile lenses. Storage case included.

Kit includes:

- 1 Bottle of lens cleaner (30 ml)
- 1 Ultra soft duster brush
- 1 Cleaning cloth (20 x 20 cm)
- 3 Books of lens paper (25 sheets each)

Kit

No. 29000-10

Lens Paper

15 x 10 cm

Book of 50 sheets

No. 29015-50



Instrument Marking Tape

Organize instruments quickly and easily with this economical, non-toxic, pressure sensitive tape. Color is unaffected by boiling, cold sterilization or autoclaving. 8 colors available. **Autoclavable.**

Material: Vinyl
290 x 0.6 cm (each roll)



Green
No. 29071-01



Blue
No. 29071-02



Yellow
No. 29071-03



Red
No. 29071-04



White
No. 29071-05



Black
No. 29071-06



Brown
No. 29071-07



Orange
No. 29071-08

**Instrument Marking Tape
8 Assorted Colors**

Organize instruments quickly and easily with this economical, non-toxic, pressure sensitive tape. Color is unaffected by boiling, cold sterilization or autoclaving. Includes 8 assorted color rolls: Yellow, Red, Black, White, Green, Brown, Blue and Orange. **Autoclavable.**

Material: Vinyl
107 x 0.6 cm (each roll)

No. 29080-00



Instrument Tip Protectors

These tip protectors are a convenient, color-coded way to protect surgical instrument tips and edges. They provide exceptional protection and are vented to prevent rusting from condensation. Instrument tip protectors are recommended during handling, storage, and sterilization. **Autoclavable.**
Material: Plastisol



1.6 x 19.1 mm

Pkg. of 25
No. 29060-01



2 x 19 mm

Pkg. of 25
No. 29060-02



2.8 x 19.1 mm

Pkg. of 25
No. 29060-03



3.2 x 25.4 mm

Pkg. of 25
No. 29060-04



4.8 x 25.4 mm

Pkg. of 25
No. 29060-05



2 x 9.5 x 25.4 mm

Pkg. of 25
No. 29060-06



Assorted pack, five of each size

Pkg. of 30
No. 29060-00

MOST POPULAR

Double Tip Protectors

These vented tip protectors are designed to hold hemostats and rongeurs firmly while allowing the jaws, box hinge and tips to stay open for thorough sterilization. **Autoclavable.**
Material: Plastisol



12.7 x 20 mm

Pkg. of 10
No. 29066-01



9 x 25.5 mm

Pkg. of 10
No. 29066-02



15 x 25 mm

Pkg. of 10
No. 29066-03



25 x 26 mm

Pkg. of 10
No. 29066-04



Assorted pack, three of each size

Pkg. of 12
No. 29066-00

Self Sealing Sterilization Pouches

Preformed pouches with self adhering tape are blue tinted on one side for visualization of contents, and paper-backed on the other side. Pouches will work with either steam autoclave or ethylene oxide sterilization.

Advantages:

- Protects instruments during sterilization.
- Provides sterile storage until use.
- Write on pouches for easier identification during sterilization.



10 x 18 cm
For instruments up to 13 cm long

Pkg. of 100 pouches
No. 28000-07

13 x 26 cm
For instruments up to 23 cm long

Pkg. of 100 pouches
No. 28000-10

18 x 30 cm
For instruments up to 26 cm long

Pkg. of 100 pouches
No. 28000-12

Hot Bead Sterilizer

The sterilizer provides a safe, effective and convenient method for sterilizing your surgical instruments prior to and during surgery or tissue culture. Without using potentially dangerous gases, flames or chemicals, you can ensure that your instruments will be free of pathogens and microbial contaminants.

The beads take 15–20 minutes to reach 240°C to 270°C (464°F to 518°F), and then the sterilizer is ready for use. The temperature is thermostatically maintained, and the unit can be left on all day. Instruments require approximately 20 seconds of contact with the beads for complete sterilization. The sterilizer is safe to use even in laminar flow hoods.

Sterilization test results conducted by the Pasteur Institute in Lille, France, are available upon request. Available in 110V and 220V. CE Certified and UL Approved.

Sterilizer includes:

- Sterilizer unit
- 2 Bags of glass beads
- 1 Dust cover for well
- 1 Small heat-tempered glass dish for small objects (only with FST 250)



FST 250 shown.
Instruments not included.

STERILIZER

FST 250 Sterilizer

Well diameter: 4 cm
Well depth: 8 cm
Well volume: 100 ml
Total unit size: 14.5 x 12.5 x 13.5 cm

No. 18000-45

Replacement glass beads for FST 250
No. 18000-46

FST 350 Sterilizer

Well diameter: 4 cm
Well depth: 14 cm
Well volume: 175 ml
Total unit size: 20.5 x 12.5 x 13.5 cm

No. 18000-50

Replacement glass beads for FST 350
No. 18000-51

Autoclave Tape Dispenser

Easy loading core with heavy duty steel construction and a non-skid base. Serrated cutting blade cuts tape fast and cleanly.



Coated steel
23.5 cm

Tape sold separately.

No. 28001-00

Autoclave Tape

Tape will permanently indicate diagonal stripes after exposure to steam autoclave temperature between 121°C and 130° C during a 40-60 minute time period. Use with sterilization pouches, sterilization wraps and sterilization cases.

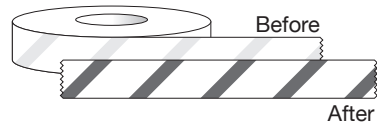

2 cm x 55 m

No. 28001-02

Surgical Skin Marker

This marker features a versatile tip for precise fine (0.2 mm) line marking, or when held at an angle, a broad (2 mm) line marking.

The marker's violet ink is nontoxic, non-tattooing and surgical prep-resistant. Markings can be removed from the skin with isopropyl alcohol. A six-inch ruler calibrated in both centimeters and inches is included.

14 cm

No. 18000-30



80% of actual size

Silicone Mat

High quality, extra soft mat for safe and secure placement of delicate instruments. This mat can easily be cut along the premarked grooves to fit in various sized instrument cases. **Autoclavable.**

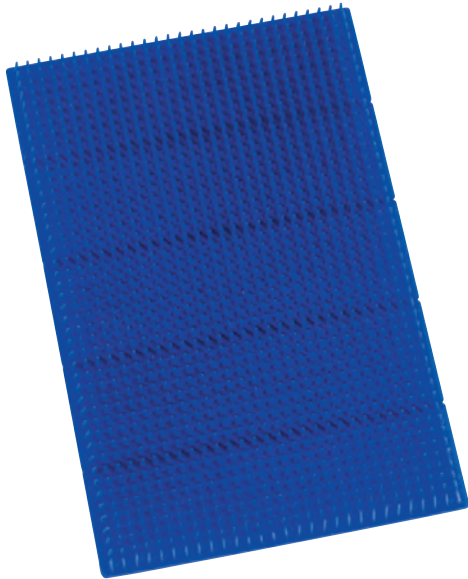

30 x 20 cm

No. 20325-00

Magnetic Sterilization Mat

Used during sterilization and for safe anti-slip placement around surgical settings. **Autoclavable.**



Instruments not included.

30 x 20 cm

No. 20350-00

Silicone Mat

Large, economical silicone mat. **Autoclavable.**

46 x 25 cm

No. 20325-10

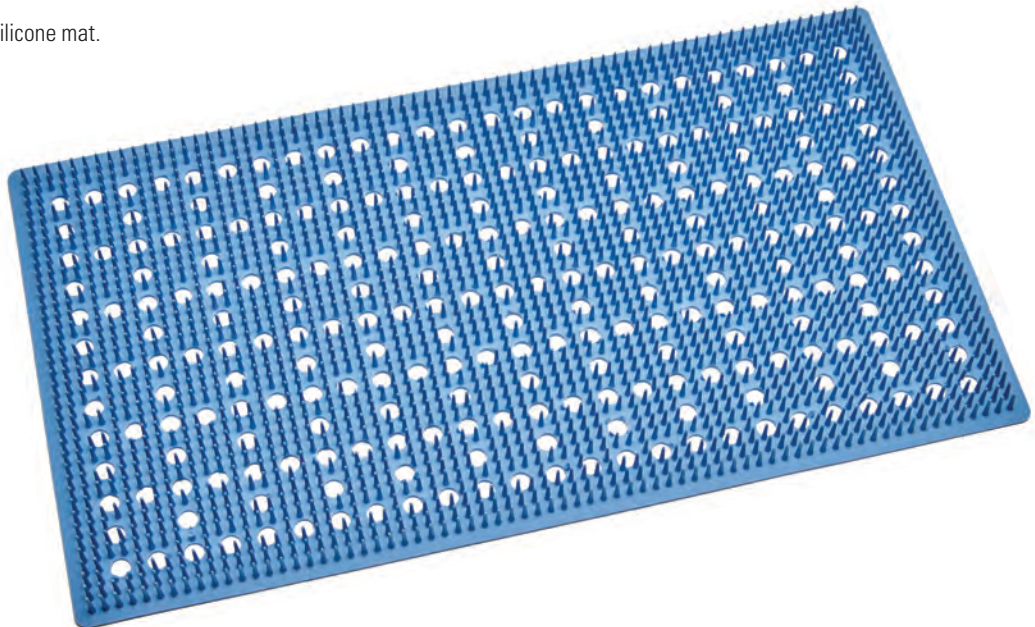

Sterilization Container

This plastic sterilization container includes a silicone mat for safe placement of instruments. Perforated top is clear for visual identification of instruments. **Suitable for autoclave or ethylene oxide sterilization.**



19 x 10 x 2 cm
No. 20810-01

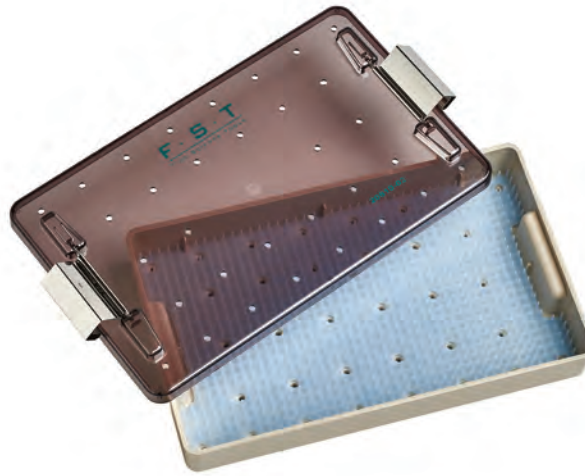

27 x 16 x 4 cm
No. 20810-02



Two Tiered Sterilization Container

This plastic sterilization container has two tiers of silicone slots that will accommodate up to 12 different instruments. Hinged top and bottom lock tight. Container is perforated. **Suitable for autoclave or ethylene oxide sterilization.**

25 x 12 x 3 cm
No. 20820-00

CASES & WRAPS

Disposable Sterilization Wraps

These biodegradable cellulose fiber wraps are resistant to tears and conform easily to maintain a breathable yet impervious barrier to airborne bacteria, saline, blood and water. Wrapping your instrument case securely will ensure the sterility of your instruments until ready for use. Available in two sizes.

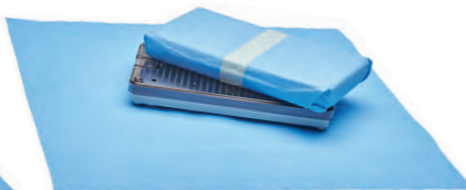

38 x 38 cm

51 x 51 cm

Pkg. of 25 wraps
No. 28015-15

Pkg. of 25 wraps
No. 28020-20

Cases not included.

Sterilization Container

This sterilization container is made from Ultem® polymer to ensure strength and long lasting durability. The transparent perforated lid provides easy identification of your surgical instruments. Silicone mat is included for a safe and secure hold. Trays are also stackable for convenience. **Suitable for autoclave or ethylene oxide sterilization.**

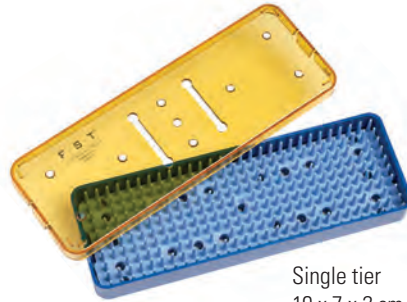

Single tier
19 x 7 x 2 cm

No. 20840-01

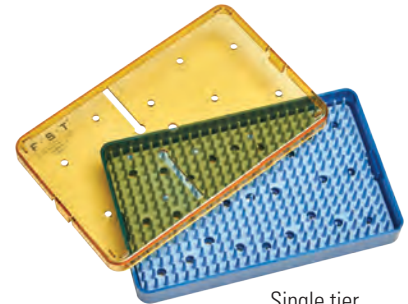

Single tier
17 x 10 x 2 cm

No. 20840-02

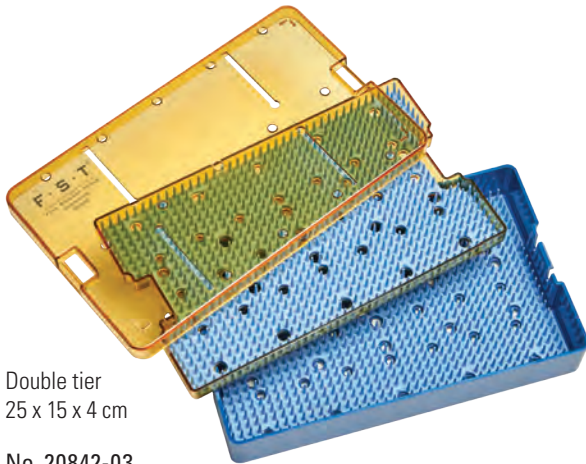

Double tier
25 x 15 x 4 cm

No. 20842-03

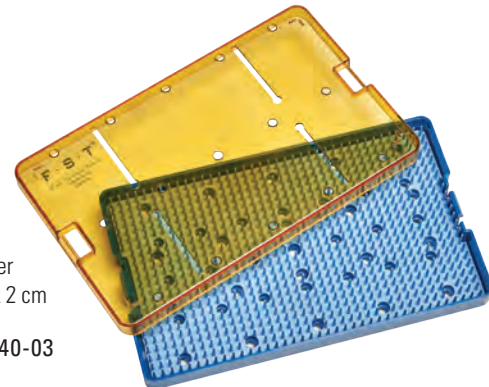

Single tier
25 x 15 x 2 cm

No. 20840-03

Dual Clasp Stainless Steel Sterilization Container

This container will assist in the sterilization and storage of your fine surgical instruments. It comes with a custom fit silicon mat and one single-use filter for keeping the instruments sterile while they remain in the container. **Suitable for autoclave or ethylene oxide sterilization.**



30 x 14 x 4 cm

No. 20850-00

5 Long-term textile filters
No. 20850-10

Stainless Steel Sterilization Container

Removable perforated interior plates hold long-term textile filters which keep the instruments sterile while they remain in the container. Lid can be locked in place. Comes with two textile filters installed. **Suitable for autoclave or ethylene oxide sterilization.**



20 x 10 x 4 cm

No. 20890-51

10 Long-term textile filters
No. 20890-72

Deluxe Stainless Steel Instrument Case

This case is built to withstand the roughest lab use. The lid is hinged and has a secure locking clasp. The inside bottom of the case is lined with a silicone mat which will cushion the most delicate instruments against impact.

The inside top of the lid has two specially shaped silicone strips which press down gently on the instruments inside the case as the lid is closed, holding them securely in place.

Case and silicone inserts are autoclavable but should not be used for sterilizing surgical instruments.

20 x 14 x 5 cm

No. 20020-00

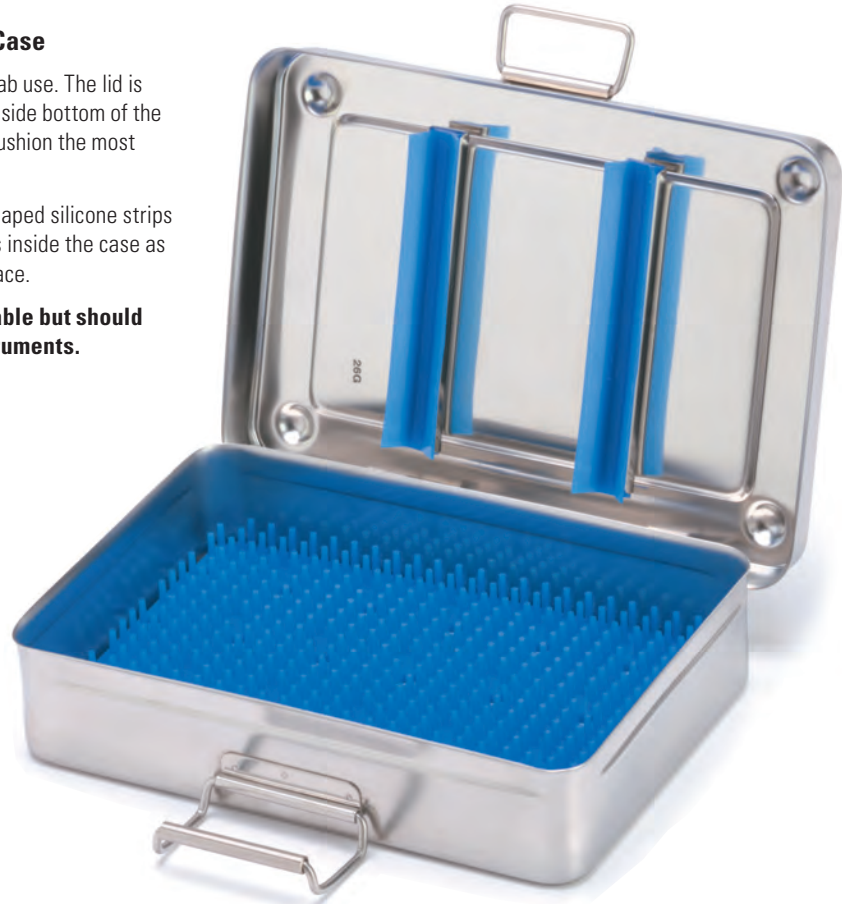

Utility Instrument Case

Comes with a silicone mat for safe placement of instruments. **Case and silicone insert are autoclavable but should not be used for sterilizing surgical instruments.**

18 x 9 x 3 cm

No. 20311-21

MOST POPULAR



Instrument Case

This plastic case is compact, safe, secure, and slotted for placement of individual surgical instruments, aiding in the prevention of tip damage. Five colors available.

Case is autoclavable but should not be used for sterilizing surgical instruments.

17 x 8 x 2 cm

MOST POPULAR



Instruments not included.



CASES

NEW ITEM



Blue

No. 20830-00



Green

No. 20830-01

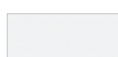

Clear

No. 20830-02

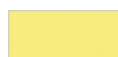

Yellow

No. 20830-03



Pink

No. 20830-04



Orange

No. 20830-05



Purple

No. 20830-06



Instrument Beaker with Silicone Bottom

Instruments are placed in the beaker with their tips immersed in distilled water when not in immediate use. This keeps the instruments clean and functional and ready to grasp. The instrument tips are protected from damage by the soft silicone rubber bottom. Segmented lid keeps instruments organized and secure.

Diameter: 10 cm
Height: 8 cm

No. 00081-00

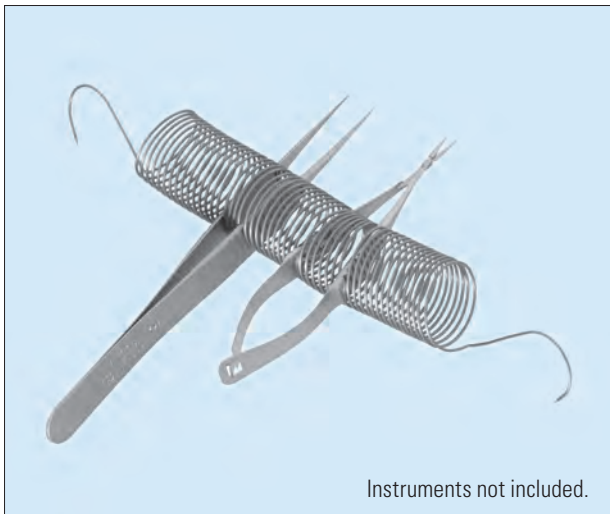

Instrument Holding Spring

For the safe placement of delicate surgical instruments during use. Pin the sharp ends into the drape to secure the mounting spring.

Diameter: 2 cm
Length: 4 cm (closed)

No. 18090-00

Stainless Steel Burrs

Shaft diameter: 2.3 mm
Length: 44 mm
Pkg. of 10 burrs



Diameter (mm)	Item	Price
0.7*	No. 19008-07	
0.9**	No. 19008-09	
1.4	No. 19008-14	

* Use this size for screws No. 19010-10.
** Use this size for screws No. 19010-00.

Carbon Steel Burrs

Shaft diameter: 2.3 mm
Length: 44 mm
Pkg. of 10 burrs



Diameter (mm)	Item	Price
0.5	No. 19007-05	
0.7*	No. 19007-07	
0.9**	No. 19007-09	
1.4	No. 19007-14	
2.1	No. 19007-21	
2.9	No. 19007-29	

* Use this size for screws No. 19010-10.
** Use this size for screws No. 19010-00.

MOST POPULAR

Tungsten Carbide Burrs

Shaft diameter: 2.3 mm
Length: 44 mm
Pkg. of 5 burrs



NEW ITEM

TUNGSTEN CARBIDE

For more information see page 183.

Diameter (mm)	Item	Price
0.5	No. 19009-05	
0.7*	No. 19009-07	
0.9**	No. 19009-09	

* Use this size for screws No. 19010-10.
** Use this size for screws No. 19010-00.

Stainless Steel Trehines

Side opening for clearing of material.

Shaft diameter: 2.3 mm
Length: 44 mm
Sold individually



1.8 - 2.7 mm



5 mm

Diameter (mm)	Item	Price
1.8	No. 18004-18	
2.3	No. 18004-23	
2.7	No. 18004-27	
5	No. 18004-50	

DRILL BITS

Stainless Steel Circular Saw

For cutting bone and other hard substances.
Attaches to mandrel (No. 18000-18), right.

Diameter: 16 mm
Thickness: 0.1 mm



Pkg. of 10 saws
No. 18000-20

Stainless Steel Mandrel

Screw allows attachment of discs and circular saws for use with high speed drills.

Shaft diameter: 2.3 mm
Length: 45 mm



No. 18000-18

Low Cost Cautery Kit

This low cost, high temperature cauterizer is a great alternative to disposable cautery units. Temperature at tips is approximately 1000°C (1832°F). Replacement cautery tips are available. **Not autoclavable.**



Plastic body
Stainless steel tips: 0.2 mm diameter
Total weight: 60 g
Length: 17.5 cm (without tip)

- Cautery kit includes:
- 1 Cautery handle
 - 2 AA Batteries
 - 2 Standard tips
 - 1 Storage case
 - 2 Fine tips

Cautery kit
No. 18010-00

65% of actual size



Replacement tips
Straight standard

Box of 10 tips
No. 18010-01



Replacement tips
Straight fine

Box of 10 tips
No. 18010-02

Small Vessel Cauterizer

This small hand-held unit keeps bleeding to a minimum and therefore provides a surgical field clear of clamps and hemostats. The cauterizer should be activated momentarily so the delicate tips do not burn out. Temperature at tips is approximately 1000°C (1832 °F). Replacement cautery tips are available. **Autoclavable.**



Heavy gauge stainless steel body
Platinum-iridium tips: 0.3 mm diameter
Total weight: 100 g
Length: 13.5 cm (without tip)

- Cautery kit includes:
- 1 Cautery handle
 - 2 AA Batteries
 - 1 Straight fine tip
 - 1 Storage Case
 - 1 Angled fine tip

Cautery kit
No. 18000-00

Cautionary note:
Remove batteries before autoclaving.

65% of actual size



Replacement tip
Straight fine

No. 18000-01



Replacement tip
Angled fine

No. 18000-02



Replacement tip
Straight knife

No. 18000-03



Replacement tip
Straight knob

No. 18000-04

Neuro Punches

N.I.H. style neuro punches for punch removal of frozen brain microregions.

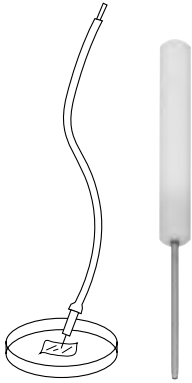

ID (mm)	OD (mm)	Gauge	Length (cm)	Item	Price
0.31	0.61	24	4.2	No. 18036-24	
0.41	0.70	22	4.5	No. 18036-22	
0.69	1.00	19	4.5	No. 18036-19	

Sample Corers

For quantitative analysis. Comes with plunger.

8.5 cm

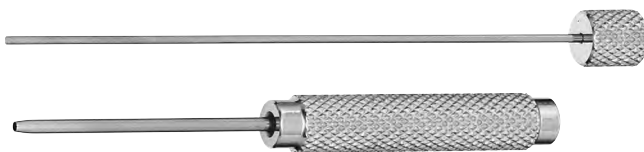

ID (mm)	OD (mm)	Gauge	Item	Price
0.35	0.80	21	No. 18035-35	
0.50	1.00	19	No. 18035-50	
0.80	1.45	17	No. 18035-80	
1.00	1.80	15	No. 18035-01	
2.00	3.00	11	No. 18035-02	
3.00	4.00	8	No. 18035-03	
5.00	6.00	4	No. 18035-05	

Absorption Spears and Triangles

These synthetic surgical sponges absorb fluids twice as fast as the best cotton sponges and have three times their fluid-holding capacity. They are made from strong, soft, lint-free biocompatible-proven material that is non-irritating to delicate tissue and leaves no fibrous residue that might cause wound contamination. The Absorption Spears are sterilized by radiation.



Absorption Spears
Sterile
7 cm

Box of 200 spears
No. 18105-01

Absorption Triangles
Sterile
2 cm

Box of 500 triangles
No. 18105-03

Miniature File Set

Comes with 8 different file profiles in a vinyl pouch.
Not autoclavable.



10 cm
 No. 30076-14

Screwdriver Set

6 screwdrivers with nickel-plated handles, hardened blades of 1, 1.5, 1.8, 2.3, 2.9 and 3.6 mm width. Comes in a wooden case.



No. 30090-06

TOOLS

4-in-1 Screwdriver

With 4 hardened, interchangeable blades stored in handle: 1.5, 2, 2.5, and 3 mm.

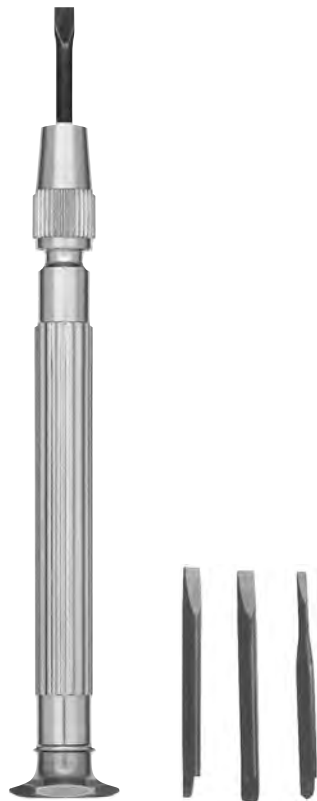

10.5 cm

No. 30051-10

Utility Scissors

These scissors are extremely hard (54 on the Rockwell scale). Useful for cutting tin or aluminum sheets, bone, plastics, etc. The strong, 3 mm thick blades are magnetic. The plastic handles are anatomically shaped. **Not autoclavable.**



75% of actual size

Stainless steel with plastic handle
21 cm

Right-handed
No. 37500-00



No. 37000-00

Ruler with Gauge Measurements

Stainless steel

15 cm (6")
No. 30085-15

90% of actual size

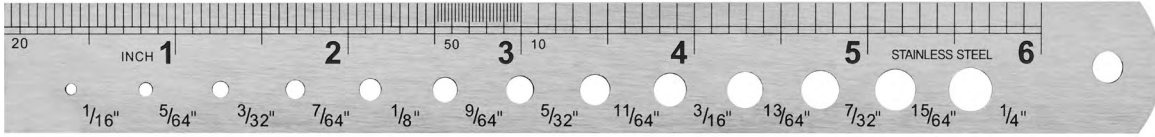

Front

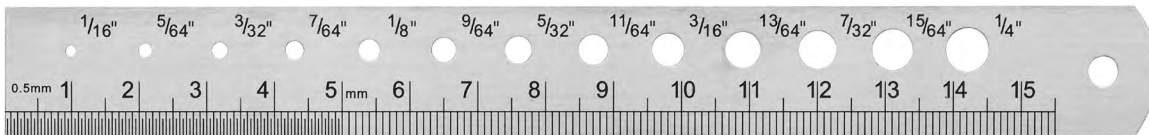

Back

Ruler with Metric Conversion Table

Stainless steel

30 cm (12")
No. 30085-30

50% of actual size



Front



Back

Ruler Label

Used for stable measurements in all surgical platforms.

6 cm

Pkg. of 25 labels
No. 29027-00



Plastic Vernier Caliper

Tough polymer is unbreakable under normal conditions. Measures inside, outside, step and depth, metric and inch to 0.1 mm or 1/64". Capacity is 13 cm.



75% of actual size

21 cm

No. 30087-20

Digital Electronic Caliper

Wide screen LED display with the ability to measure in millimeters, inches and fractions. Measures inside, outside, step and depth. Battery, spare battery and plastic storage case included.



70% of actual size

Stainless steel
23.5 cm

No. 30087-00

Castroviejo Surgical Caliper

Used for precise measurement during surgery.



0-20 mm with 0.5 mm divisions
Tip diameter: 0.5 mm
8.5 cm

No. 18000-35

CALIPERS

Magnifying Loupe with Micrometer and LED

High quality loupe features a removable micrometer and ultra-bright LED lights surrounding the circumference for a defined image and clear contrast.

Magnification: 10x
 Field of view: 30 mm
 Working distance: 10 mm (without scale)
 Illumination: Ultra-bright LED
 38 x 38 x 40 mm

No. 29026-10



Large Scale Stage Micrometer

A precision glass scale suitable for calibration and measurement of large field stereo microscope images. Comes with 15x eyepiece and case.

50 mm with 500 divisions (0.1 mm)
 80 x 25 mm
 8 cm

No. 29026-00



Stage Micrometers

These are highly accurate stage micrometers for use with transmitted light in both compound and stereo microscopes. Comes with a plastic case.

76 x 26 mm

10 mm with 100 divisions (0.1 mm)
 No. 29025-01

1 mm with 100 divisions (0.01 mm)
 No. 29025-02

Electronic Clock / Triple Timer

Three activities can be timed up or down simultaneously or individually. Time can be displayed either in 12 or 24 hours and features a memory function. Maximum countdown time is 19 hours, 59 minutes, 59 seconds. Minimum time interval is 1 second. The timer housing includes a powerful magnet for mounting.

LCD display: 4.5 x 4.5 cm

7 x 8.5 x 1.5 cm

AAA battery included

No. 27000-01



Gold Wire Contacts

Matching pin and socket. Contacts are crimp terminated, but also can be used for solder connections.

Total length: 16 mm (when connected together)

Diameter: 1.2 mm

Opening for wire: 0.63 mm

Pkg. of 50 male contacts

No. 19003-00

Pkg. of 50 female contacts

No. 19003-01

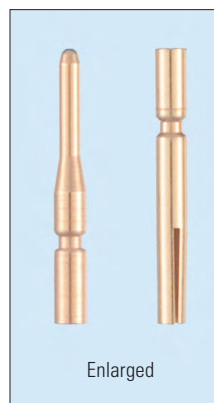

Headband Magnifier

Precision ground and polished optical glass lenses. The padded headband is lightweight and fully adjustable. Can be worn with spectacles.



Headband magnifier shown with VisorLIGHT™ (sold separately).

MAGNIFIERS

Magnification: 2.5x
Working distance: 200 mm (8")

No. 28030-02

Magnification: 2.75x
Working distance: 150 mm (6")

No. 28030-03

Magnification: 3.5x
Working distance: 100 mm (4")

No. 28030-04

VisorLIGHT™

Small, portable light source with 3.9 cm cord for attachment to headband. It comes with a battery pack that holds two AA batteries. Completely adjustable. Replacement bulbs are available upon request.



No. 28030-10

Interchangeable Magnifier Headset with LED

Economical and fully interchangeable headband magnifier with LED light.

Includes:

- Glasses Frame with Adjustable Lens Holder
- Adjustable Head Strap
- Magnification Lenses (1x, 1.5x, 2x, 2.5x, and 3.5x) with a protective storage box
- 2 Super Bright White LED bulbs
- 3 AG10 Batteries

Magnification: 1x, 1.5x, 2x, 2.5x, and 3.5x

Field of view: Variable

Working distance: Variable

No. 28080-00

**MOST
POPULAR**



Can be used with or without the adjustable head strap (included).

Galilean Loupes

These loupes are lightweight and easy to use. Made from the finest optical coated lenses which deliver excellent clarity and high resolution. The loupes are mounted onto a strong yet flexible wraparound safety frame with a headband for stability and comfort. Ability to flip loupes up for use as safety glasses. Comes with mini screwdriver for fine adjustments, micro cloth, and storage case.

Magnification: 3x
Working distance: 400 mm (16")
Weight: 72 g

No. 28050-30

Magnification: 3.5x
Working distance: 300 mm (12")
Weight: 77 g

No. 28050-35



MAGNIFIERS

Eschenbach Magnifier Spectacles

These magnifier spectacles allow full adjustments on almost all parts. Headband keeps spectacles steady and in place. (Sold separately.) Leather case included.

Magnification: 2.5x
Working distance: 350 mm (14")
Weight: 70 g
Plastic frame reinforced with fiberglass

No. 28040-30



Spectacles Headband

Compatible with the Eschenbach Max Detail Spectacles (Item No. 28030-20) and Eschenbach Magnifier Spectacles (Item No. 28040-30).

Material: Neoprene

No. 28080-90



Eschenbach Max Detail Spectacles

These spectacles are portable, lightweight, and easily adjustable. Designed with frosted objective lens housing which eliminates distracting reflections. Bendable ear pieces for a secure, comfortable fit. Protective case is included.

Magnification: 2x

Field of view: 110 mm (4")

Working distance: 400 mm (16")

Weight: 49 g

No. 28030-20

**MOST
POPULAR**



Max Detail Spectacles shown with Eschenbach Clip-On LED Light (sold separately).

Eschenbach Clip-On LED Light

A compact and lightweight light source with two high-performance SMD LED's and a lens that concentrates the light producing a more powerful, bright and homogenous field of view. Light can be set high or low. Compatible with the Max Detail Spectacles and Headband Magnifiers. Comes with 3 AA batteries and storage case.

Weight: 11 g

No. 28030-25





Optical Cleaning Kit

This convenient kit contains everything you need to clean lens surfaces safely. Perfect for microscopes, camera lenses, binoculars, telescopes, graphic art optics, and all other fragile lenses. Storage case included.

Kit includes:

- 1 Bottle of lens cleaner (30 ml)
- 1 Ultra soft duster brush
- 1 Cleaning cloth (20 x 20 cm)
- 3 Books of lens paper (25 sheets each)

No. 29000-10



Lens Paper

This premium grade optical lens tissue is extremely soft and safe for any glass or plastic optical lens surface.

15 x 10 cm

Book of 50 sheets

No. 29015-50

Eschenbach Vario Flex with LED

The Vario LED Flex ensures ease and precision by its smooth flexible neck and tiltable magnifying lens. This magnifier's innovative features provide a spacious working platform suitable for any application. Mounting clamp provides uncompromised workspace due to its sturdy, slim design. The magnification lens is illuminated with shadow-free full or half ring optimum bright LEDs.

Magnification: 2.5x

Diopter: 6D

Lens size: 76 mm

Lens shape: Aspheric

Working distance: Variable

Lens material: PXM® lightweight lens with patented

Ceratec® scratch-resistant coating

Illumination: Latest SMD LED technology

Power source: 120V & 220V

No. 28015-25



Eschenbach Scribolux Magnifier

This magnifier provides an illuminated platform suitable for any working condition. The open design allows for a spacious working platform. Supplied in a microfiber pouch for protecting and cleaning the lens.

Magnification: 2.8x

Diopter: 7/11D

Lens size: 100 x 75 mm

Lens shape: Aspheric

Working distance: 75 mm (3")

Lens material: PXM® lightweight lens with patented

Ceratec® scratch-resistant coating

Illumination: Latest SMD LED technology

Power source: 4 AA batteries (included)

No. 28020-28



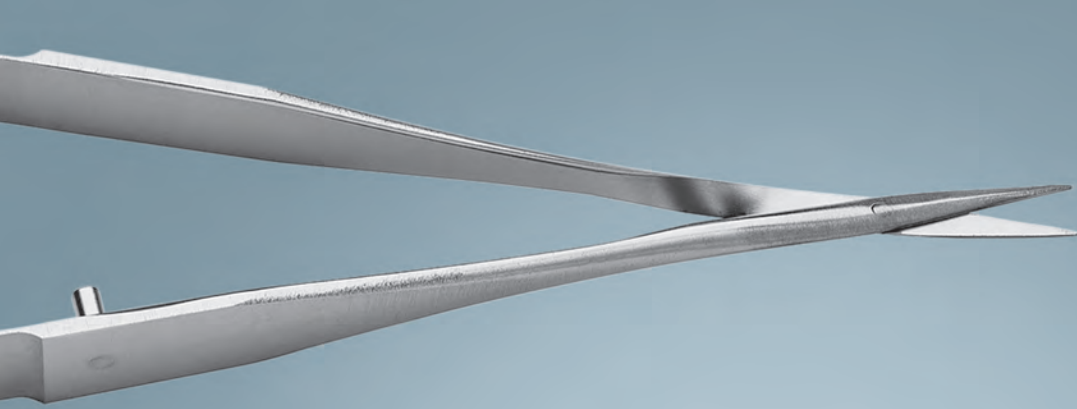

Student Quality Instruments

Scissors	Pages	173 – 174
Vessel Dilator	Page	175
Forceps	Pages	175 – 177
Hemostat, Needle Holder, Pin Holder, Scalpel Handle & Retractor	Pages	178 – 179



Vannas Spring Scissors

Ideal for introductory courses in microdissection. The manufacturer, material and general pattern are the same as our No. 15003-08 but with much of the costly hand finishing omitted.



Cutting edge: 5 mm
Tip diameter: 0.35 mm
9 cm



Straight

No. 91500-09



Curved

No. 91501-09

MOST POPULAR

Fine Scissors

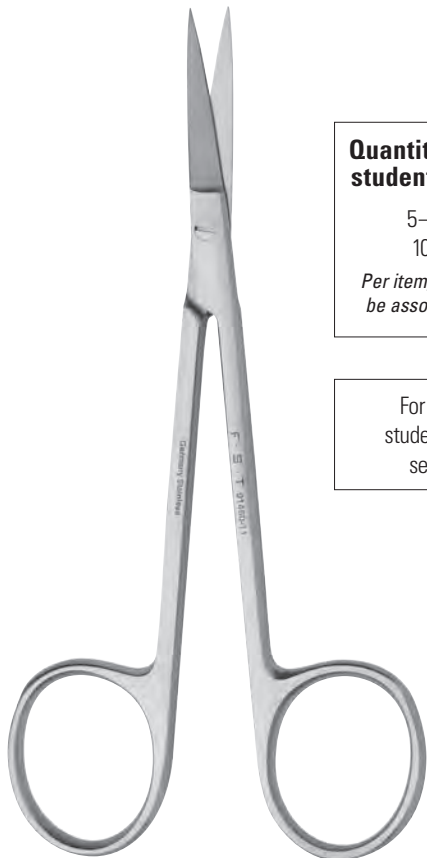

11.5 cm



Straight

No. 91460-11



Curved

No. 91461-11

MOST POPULAR

Quantity discount for student instruments:

5-9 = 5%

10+ = 10%

Per item, selection cannot be assorted for discount.

For more info on student instruments see page 187.

Surgical Scissors



90% of actual size



Sharp/Sharp

10.5 cm
No. 91402-10



Sharp/Blunt

10.5 cm
No. 91401-10



Blunt/Blunt

10.5 cm
No. 91400-10

12 cm
No. 91402-12

12 cm
No. 91401-12

12 cm
No. 91400-12

14.5 cm
No. 91402-14

14.5 cm
No. 91401-14

14.5 cm
No. 91400-14

Lister Scissors

Longer blunt blade prevents damaging tissue underneath skin without losing the cutting line.



Angled to side
Blunt/Blunt
14 cm

No. 91413-14

Bone Scissors

For cutting fine bone.



Curved
Cutting edge: 9 mm
9 cm

No. 91604-09

Quantity discount for student instruments:

5-9 = 5%
10+ = 10%

Per item, selection cannot be assorted for discount.

For more info on student instruments see page 187.

Vessel Dilator



Angled 10°
Tip diameter: 0.5 mm
11 cm
No. 91815-11

Standard Pattern

Broad pattern with strong spring action.



Quantity discount for student instruments:
5-9 = 5%
10+ = 10%
Per item, selection cannot be assorted for discount.

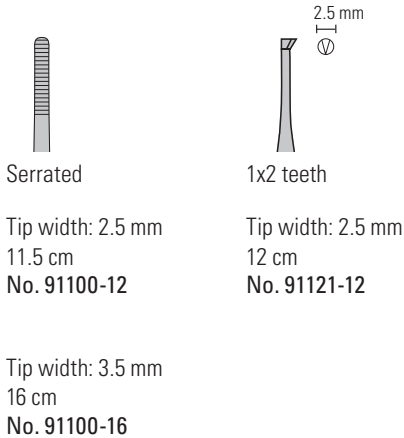

Adson

Wide, strong grip with narrow tips.

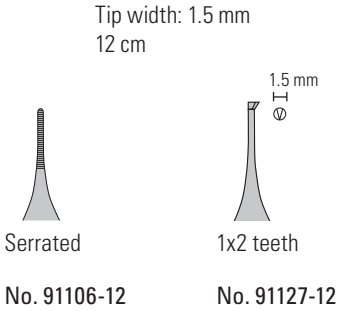

STUDENT

Dumont #5

Dumont #7

Quantity discount for student instruments:

5-9 = 5%
10+ = 10%

Per item, selection cannot be assorted for discount.

For more info on student instruments see page 187.



MOST POPULAR

Standard tip
0.1 x 0.06 mm
Inox
11 cm

No. 91150-20

Standard tip
0.17 x 0.1 mm
Inox
11 cm

No. 91197-00

STUDENT

**Fine Forceps
Straight**



0.2 x 0.1 mm
11 cm

No. 91115-10

**Fine Forceps
Broad Shanks**



0.2 x 0.2 mm
12 cm

No. 91113-10

**Quantity discount for
student instruments:**
5-9 = 5%
10+ = 10%
*Per item, selection cannot
be assorted for discount.*

**Fine Forceps
Curved**



0.2 x 0.2 mm
12 cm

No. 91117-10

**Fine Forceps
Angled**



0.2 x 0.2 mm
11 cm

No. 91110-10

STUDENT

Halsted-Mosquito Hemostat

Halsey Needle Holder

Quantity discount for student instruments:
 5-9 = 5%
 10+ = 10%
Per item, selection cannot be assorted for discount.

For more info on student instruments see page 187.



Straight
12.5 cm

No. 91308-12



Curved
12.5 cm

No. 91309-12



13 cm

No. 91201-13

For suture needles, see page 116 & 117.

STUDENT

Pin Holder

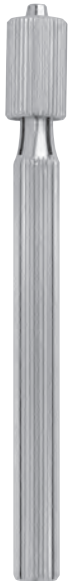

Nickel-plated
Jaw opening: 0-1 mm
7.5 cm

No. 91606-07

For pins, see
page 107.

**Standard Scalpel
Handle #3**



12 cm

No. 91003-12

For scalpel blades,
see page 58.

**Quantity discount for
student instruments:**
5-9 = 5%
10+ = 10%
*Per item, selection cannot
be assorted for discount.*

Spring-Loaded Retractor



Curved atraumatic blades
Maximum spread: 3 cm
Blade dimensions: 14 x 10 mm
8.5 cm

No. 91706-05

STUDENT



Reference Pages

Worldwide Locations	Page	181
Scissors Test	Page	182
Features and Alloys	Page	183
Maintenance and Care	Pages	184 – 185
Quality Control	Page	186
Student Line	Page	187
Selection	Page	188
Dumont	Page	189
Numerical Index	Pages	190 – 193
Alphabetical Index	Pages	194 – 199
Additional Information	Page	200

Fine Science Tools Around the World

Commitment to excellence

For decades, we've demonstrated our commitment to excellence with genuine quality and a 100% satisfaction guarantee. As a result, our products continue to be the preferred instruments among scientists and biomedical researchers worldwide.

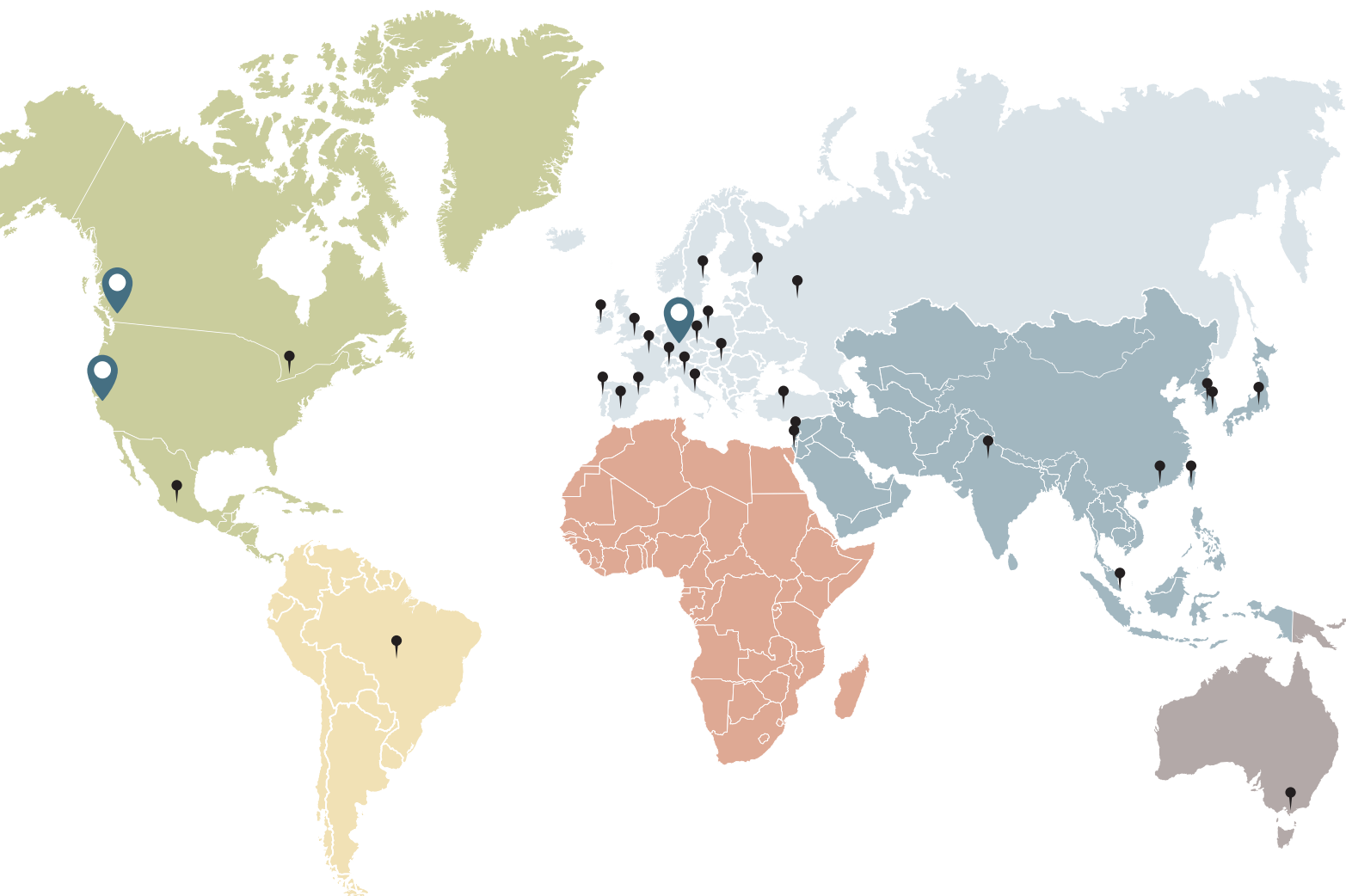

We have offices and dealers throughout the world and have been shipping globally since 1974.

	Offices	
	finescience.com	USA
	finescience.de	Europe
	finescience.ca	Canada/International

	Dealers
	To see a complete list of Fine Science Tools dealers, please visit us at finescience.com/Dealers .

WORLDWIDE

Does paying more for a pair of scissors really buy more value and a longer cutting life?

Pictured below is a scissors testing device used to compare various alloys and cutting edge styles. The scissors repeatedly cut through a continuous feed of cotton cloth, and a counter keeps track of the number of cuts made to evaluate when the scissors begin to show a decrease in cutting quality.

The results verify that the addition of various features dramatically increases the cutting life of the scissors. Most notably, the cutting life is more than doubled with the addition of ToughCut blades to stainless steel, and over six times longer with CeramaCut blades.

See the chart below for a comparison of four different scissors sold by FST.



The cutting life is more than doubled with the addition of ToughCut blades to stainless steel, and over six times longer with CeramaCut blades.

Alloy/Material	Lasts longer than stainless steel by:
Tungsten Carbide	1.9x
Stainless Steel with ToughCut	2.3x
Tungsten Carbide with ToughCut	4.1x
CeramaCut (Ceramic Coated Tungsten Carbide with ToughCut)	6.6x

See page 183 for more information on ToughCut, Tungsten Carbide and CeramaCut.

Tungsten Carbide

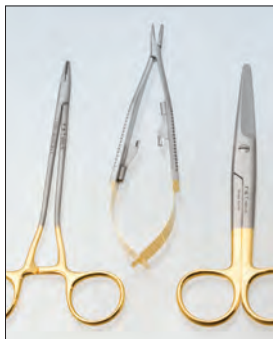

When you place heavy demands on your surgical instruments, be it scissors, needle holders, or forceps, you should consider the benefits of tungsten carbide, one of the hardest alloys available. Tungsten carbide scissors last almost two times longer than stainless steel, and needle holder tips can be made with a pyramid cross pattern that holds suture needles much more securely. Inlays are either glued or welded into place.

Compare the extra cost of these instruments with the length of useful wear and you have a cost effective solution for your instrument requirements. Tungsten carbide instruments are identified by their gold handles.

Scissors: pages 9, 20–21, 23, 30–32, 34 and 44

Forceps: page 84

Needle Holders: pages 111–115

Burrs: page 157

Look for this symbol



ToughCut® Scissors



ToughCut scissors feature two unique cutting edges that cut through the toughest tissue with exceptional ease and accuracy. One blade is honed to razor sharpness, and the other is micro-serrated to minimize tissue slippage during cutting. Scissors with ToughCut edges are identified by their black handles.

For ToughCut scissors that last almost two times longer, select ToughCut with tungsten carbide cutting edges.

Scissors: pages 6, 15, 20–21, 30, 33–34

Look for this symbol



Ceramic and CeramaCut® Instruments



One of the hardest materials on Earth, ceramic is used in surgical instruments to form edges that last longer than stainless steel and even longer than tungsten carbide. Ceramic also has a high slide capacity which reduces surface tension and results in a much cleaner cut than metal instruments. Our CeramaCut scissors combine ToughCut technology with tungsten carbide edges and a ceramic coating for one of the best, cleanest cutting scissors available on the market today.

CeramaCut Scissors: page 21

Ceramic Blades: page 52

Ceramic Coated Forceps: pages 63 and 69

Ceramic Coated Spring Scissors: pages 7 and 10

Look for this symbol



Titanium

Titanium instruments are over 40% lighter than equivalent stainless steel instruments, with better flexibility and strength. Elemental titanium (Ti) is a very strong, lustrous, white metal with a specific gravity of 4.54. Titanium and titanium alloys readily form stable protective surface layers, giving them excellent corrosion resistance to saltwater, laboratory saline solutions, blood and other bodily fluids, oxidizing acids, alkalis and chlorides. Titanium is 100% nonmagnetic; a great benefit when working with nerves. Its inherent surface oxide film provides bactericidal and non-allergenic properties. Titanium alloys can be heated up to 440°C (824°F).

Scissors: pages 5 and 10

Forceps: pages 65, 69, 80, 86 and 90

Probes, Y-Hook and Spatula: page 102

Vascular Clamps: pages 132–133

Look for this symbol



Cleaning, Sterilization, Maintenance, & Storage of Surgical Instruments

Proper care of your surgical instruments will improve their longevity and function. Below are different cleaning, sterilization, and maintenance processes to guide you through your techniques.

General Care & Maintenance

Guidelines to extend the life of your surgical instruments.

- Clean and thoroughly dry your instruments as soon as possible after each use, paying special attention to joints, hinges, and anywhere there is metal to metal contact.
- Handle your instruments delicately and with care.
- Use your instruments for their intended purpose.
- Store your instruments with tip protectors, and always place them so that they do not touch each other.

Cleaning

Fine surgical instruments should be cleaned immediately after use. Blood or saline solutions left on instruments for any length of time can quickly start corrosive action. Time, temperature, and agitation play important roles in the cleaning process. Time affects the efficiency of cleaning solutions as most are effective after a certain time period. Higher temperature cleaning solutions result in better cleaning. During manual or ultrasonic cleaning it is helpful to loosen any surgical residue. Before any of the below procedures, rinse your instruments under warm running water to remove all blood and tissue. Instruments can be cleaned manually or ultrasonically, but always:

- Use a neutral pH (pH 7) cleaning solution.
 - Clean instruments in the open position to ensure a thorough and effective cleaning process.
 - Use soft textile or paper cloths, soft plastic brushes made of nylon, or water spray guns.
- Do **NOT** use steel wool, wire brushes, or scouring pads as these are abrasive to the instruments.

Manual Cleaning

- Make sure all instruments are visibly clean and free from stains, wiping them carefully to remove all blood and tissue matter.
- Rinse instruments thoroughly with distilled water, paying close attention to joints and hinges as these areas can accumulate unwanted material.
- Air dry your instruments completely and use a can of compressed air to blow out any water at the joints and hinges. Then store them only in clean and dry environments.

Ultrasonic Cleaning

Ultrasonic cleaning is the most effective cleaning method. The vibrating sound waves create micron-sized bubbles in the solution that grow with the alternating pressure. When the bubbles reach a particular size, they collapse creating a force that dislodges dirt and particles, even in the smallest of crevices.

- **NOT** recommended for delicate and micro instruments.
- Follow the manufacturer's guidelines for specific instructions and cleaning cycle times. Instruments should be processed for the full recommended cycle time.
- Place instruments in the open position in the ultrasonic cleaner.
 - Do **NOT** allow instruments with sharp blades to touch other instruments.
 - Do **NOT** place dissimilar metals (stainless, copper, chrome plated) in the same cleaning cycle.
 - Make sure all instruments are completely submerged.
- After the ultrasonic cleaning cycle is complete, rinse instruments thoroughly to remove all ultrasonic cleaning solution.
- Dry instruments thoroughly with a clean towel.
- Use a spray lubricant in the hinges to minimize the risk of corrosion and maintain functionality.

Sterilization

It is important that instruments are free from all traces of organic or other matter prior to sterilization.

Steam Sterilization/Autoclaving

The autoclave process utilizes moist heat (or steam) under pressure for sterilization. The steam used must be from distilled water and free of all impurities.

- Lubricate all instruments that have any metal to metal interaction such as; scissors, rongeurs, needle holders, hemostats, and retractors. Do **NOT** use WD-40 or other industrial lubricants.
- Instruments may be autoclaved individually or in sets.
 - **Individual instruments:** Disposable wraps or sterilization pouches are ideal. Make sure the pouch size is sufficient for the instrument to be in an open (unlocked) position.
 - **Instrument sets:** Open and unlock all instruments. Place the heavier instruments on the bottom of the set when two layers are needed.
- Do **NOT** lock instruments during autoclaving. This will prevent the steam from reaching and sterilizing the metal to metal surfaces, and heat expansion during autoclaving can cause cracks in the hinge areas.
- Do **NOT** over load the autoclave chamber as this may hinder steam penetration.
- Place a towel on the bottom of the pan to absorb excess moisture during autoclaving. Make sure the towel has no detergent residue and is pH neutral if immersed in water.
- At the end of the autoclave cycle (before the drying cycle) unlock the autoclave door and open it slightly. Run the dry cycle for the recommended time period by the autoclave manufacturer.

IMPORTANT NOTE: Do **NOT** mix instruments of different or unknown alloys in the autoclave.

Please note: If the autoclave door is fully opened before the drying cycle, cold air will rush into the chamber, which can cause condensation on the instruments. This will result in water stains on the instruments.

Hot Bead Sterilization

Recommended for speed and convenience when instrument tips or blade sterilization is required. The Hot Bead Sterilizer does not use dangerous gases, flames, or chemicals. Highlights:

- Bench top set up.
- Only 20 seconds of contact required to ensure your instruments are free of pathogens and microbial contaminants.
- Can be left on all day.
- Beads reach temperature of 240° - 270°C (464° - 518°F) within 15-20 minutes heating time.

Please see page 149 for more information on the FST Hot Bead Sterilizers.

Ethylene Oxide (ETO) Sterilization

This method is recommended for instruments that will not tolerate high temperatures or moisture (e.g., catheters, cannulae, etc.). This is a process consisting of 4 primary variables; gas concentration, humidity, temperature and time. Sterilization pouches and wraps available, see pages 148 and 152.

Storage

Surgical instruments should be properly stored in a clean and dry environment. It is highly recommended to use tip protectors and instrument cases to avoid possible damage to your instruments. Instrument tip protectors are available, see page 147. Instrument cases are available, see pages 152 – 155.

Oxidation (Rust)

All FST stainless steel surgical instruments are manufactured from medical grade stainless steel under strict European standards. It is very important to properly take care of your instruments to extend their lifespan.

Although stainless steel is corrosive resistant, it can still rust or stain if handled improperly. Under unfavorable conditions instruments may oxidize because stainless steel that is exposed to physical, thermal, or chemical manipulations may lose some of its stainless properties.

Quality Control

The high quality of Fine Science Tools surgical and microsurgical instruments is the result of our relentless attention to detail. Almost every instrument we sell is manufactured by skilled European craftsmen, designed to exacting specifications made from the finest German stainless steel alloys, and forged from the strongest, lightest materials available, and tested to ensure precision performance and ergonomics.

We are dedicated to quality control, with technicians in our German office inspecting most FST instruments. Aside from checking instrument dimensions and specifications, we thoroughly inspect tip sharpness, cutting edges, springs, joints, and other various components. Only after passing our detailed inspections, instruments are approved and sealed with our "FST Inspected" sticker.

We are proud to guarantee all of our products with your 100% satisfaction. If, for any reason, you are not completely satisfied with your purchase, you may return it for a full refund.





FST Student Quality Instruments

One of the hallmarks of FST has always been to accurately assess the needs of our customers. We gather information not only from the lab, but from conferences, journals and researchers. Whether it is designing new tools or finding new applications for existing instruments, we believe our best information comes directly from you.

Our customers wanted reduced costs and quantity discounts without sacrificing the precision and quality inherent in German instruments. To meet their needs, we have developed a full line of "student" instruments. They were created for use in the classroom where students are learning proper instrument care.

Unlike our competitors, the quality of these instruments does not drop dramatically with the price. Our student line uses quality stainless steel and maintains the precision you expect from FST. In addition they carry our unconditional satisfaction guarantee while being offered at a significantly reduced price.

Not intended as a substitute for our highest quality instruments, the student line may require extra care as the alloys used are more susceptible to corrosion. All of our shipments come with an instruction pamphlet describing the use and care of surgical instruments. Visit our website at finescience.com for more information.

Features:

- Economy
- Quantity discounts
- Quality
- German craftsmanship
- Less hand finishing
- Less expensive alloys

We Proudly Stock



Fine Science Tools is proud to offer a large selection of left-handed surgical instruments to the research community. To find our left-handed instruments in this catalog, look for the “left-handed” icon on the pages below.

Scissors: pages 17, 29 and 161

Hemostatic Forceps: page 93

Needle Holders: pages 113-114

Ligation Aid: page 135



FST features a selection of scissors with larger than normal finger loops. Most of these loops are easily adjustable to fit larger fingers more comfortably. To find our large loop scissors please look for the “large loop” icon on the pages below.

Scissors: pages 19, 28 and 31



Fine Science Tools has noted which items are most frequently purchased for use in a variety of surgical procedures. To find our most popular items, look for the “most popular” icon throughout the catalog.



Fine Science Tools offers a wide selection of the latest and most popular Dumont forceps. Hand crafted in Switzerland for more than a century, these forceps are known for their consistent and uncompromised fineness. Dumont forceps come in a wide array of styles and alloys. On page 189, you will find detailed descriptions to help guide you in choosing the right Dumont forceps best suited for your needs.



Moria of France is one of the most respected and well known ophthalmic instrument manufacturers in the world, offering some of the finest surgical instruments in the industry for almost 200 years.

Only quality Swedish and German stainless alloys are selected; and many hours of highly skilled labor are put into the manufacturing process, which includes hand crafted sharpening, balancing, and polishing, often done under 40x magnification. Moria’s product line includes scissors, spring scissors, forceps, spoons, vessel clamps, and more.



This Swiss manufacturer has established itself as one of the premier suppliers of superb microsurgical instruments worldwide. Unique designs, precise instrument balance, and optimum angles gives S&T instruments the “right feel” which is important for all procedures. S&T’s product line includes forceps, needle holders, scissors, vessel clamps, sutures, vessel cannulation forceps, vessel dilators, and more.

Finding the Dumont forceps best suited for your needs:



Alloys	Hardness	Magnetic	Temperature resistance	Autoclavable	Advantages
Titanium	Least Hard	No	Up to 430° C	Yes	Resistant to corrosion from nitric acid, chloride, and salt water. Titanium is 40% lighter than stainless steel.
Dumoxel	Hard	No	400° C	Yes	The most popular alloy available for Dumont forceps offers the best resistance to corrosion, sulphuric environments, hydrochloric acids, and all other mineral and organic acids.
Inox	Harder	Yes	400° C	Yes	Available for most Dumont forceps. Contains chromium added to carbon steel, which results in some loss of hardness but offers good stainless qualities and resistance to corrosion.
Dumostar	Harder	No	500° C	Yes	More durable and corrosion resistant than the best stainless steels. Highly resistant to mineral and organic acids, and salt water. Dumostar lasts an average of four times longer than Dumoxel and Inox. Most cost effective alloy for laboratory use.
Carbon	Hardest	Yes	N/A	No	Extremely hard; ensuring strong tips. Easily stains and rusts without proper care. Carbon cannot be immersed in a water bath or sterilized.

Tip profiles: Dimensions vary. See each style for specific dimensions (width x thickness).

Standard	Made for high precision and consistently precise work under a microscope.
Biology	Twice as fine as "Standard Tips." Especially produced for high precision laboratory work under the microscope.
Super Fine Tips	Four times finer than the "Standard Tips." These tips are extremely delicate for the finest work under the microscope. Extra care is needed for these tips as they are very fragile.

Styles	
#2	Straight forceps with wide yet fine tips, referred to as Mouse Laminectomy Forceps because of their popularity in breaking off delicate bone from mouse skulls.
#2AP	Epoxy coated with flat wide blunt tips.
#3	Long straight forceps with coarse tips. Popular in low magnification procedures.
#3C	Shorter version of #3.
#4	Similar to the #5 but with broader shanks and stronger tips.
#5	Most popular style of Dumont straight forceps with fine tips which come in several styles.
#55	Similar to the #5 but with lighter shanks, giving the forceps a lighter spring action.
#5CO	Similar to the #55 but with even finer shanks producing the lightest spring action and longest meeting surface of any Dumont style.
#5L	Medical #5 forceps with slide sleeve for a secure hold and retention.
#5SF	The finest tips ever produced by Dumont.
#5XL	Extra Long #5 forceps.
#5/45	Tips angled at 45°.
#5/45C	Designed to pick up cover slips from multi-well plates.
#5/90	Tips angled at 90°.
#6	Sharply angled, broad tips.
#7	Most popular style of Dumont curved forceps with fine tips which come in several styles.
#7B	Curved serrated tips.
AA	Strong broad tips.
M	Mini forceps.
Medical	Denotes distinctive ribbed handle to maximize grip.
SS	Long and narrow shanks with thin tips.
WA	One piece design with no soldering grooves allows the forceps to be thoroughly and easily cleaned preventing biofilm residue.

INDEX

Item No.	Page No.										
		10031-13.....	100	10097-16.....	49	11001-14.....	87	11023-14.....	88	11101-09.....	83
		10032-13.....	100	10099-12.....	105	11001-16.....	87	11023-15.....	88	11103-09.....	83
		10033-13.....	100	10099-15.....	105	11001-18.....	87	11024-18.....	91	11106-09.....	83
00071-14.....	131	10035-00.....	56	10100-30.....	52	11001-20.....	87	11025-18.....	91	11150-10.....	80
00072-14.....	131	10035-05.....	56	10100-45.....	52	11002-12.....	86	11026-15.....	89	11151-10.....	80
00081-00.....	156	10035-10.....	56	10110-01.....	53	11002-13.....	86	11027-12.....	84	11152-10.....	80
00108-11.....	75	10035-12.....	56	10110-03.....	53	11002-14.....	86	11028-15.....	89	11153-10.....	80
00109-11.....	75	10035-15.....	56	10110-05.....	53	11002-16.....	86	11029-14.....	88	11154-10.....	80
00125-11.....	136	10035-20.....	56	10110-07.....	53	11002-18.....	86	11030-12.....	85	11155-10.....	80
00126-11.....	136	10035-25.....	56	10130-05.....	107	11002-20.....	86	11031-15.....	89	11158-10.....	80
00272-13.....	77	10035-30.....	56	10130-10.....	107	11002-25.....	86	11032-12.....	84	11159-10.....	80
00276-13.....	136	10050-00.....	55	10130-20.....	107	11003-12.....	86	11036-20.....	87	11160-10.....	80
00325-00.....	130	10052-11.....	55	10140-01.....	101	11003-13.....	86	11036-90.....	87	11200-00.....	72
00396-01.....	130	10053-09.....	55	10140-02.....	101	11003-14.....	86	11040-08.....	79	11200-10.....	72
00398-02.....	130	10053-13.....	55	10140-03.....	101	11003-16.....	86	11041-08.....	79	11200-12.....	72
00400-03.....	130	10055-12.....	50	10140-04.....	101	11003-18.....	86	11042-08.....	79	11200-14.....	72
00574-11.....	139	10056-12.....	50	10152-30.....	54	11003-20.....	86	11043-08.....	79	11200-33.....	71
00632-11.....	75	10058-15.....	51	10157-13.....	54	11006-12.....	84	11049-10.....	80	11203-23.....	71
00649-11.....	75	10059-13.....	50	10157-15.....	54	11006-15.....	78	11050-10.....	80	11203-25.....	71
10000-10.....	60	10059-15.....	51	10157-18.....	54	11008-13.....	86	11051-10.....	80	11210-10.....	71
10000-11.....	60	10060-00.....	60	10160-13.....	103	11008-15.....	86	11052-10.....	80	11210-20.....	71
10000-15.....	60	10060-13.....	60	10162-12.....	99	11009-13.....	86	11053-10.....	80	11215-01.....	41
10002-00.....	59	10061-12.....	101	10165-11.....	102	11009-15.....	86	11054-10.....	80	11215-02.....	41
10002-50.....	59	10062-12.....	101	10166-11.....	102	11010-17.....	91	11055-10.....	80	11220-21.....	70
10003-12.....	58	10063-15.....	100	10167-11.....	102	11011-17.....	91	11062-10.....	81	11223-20.....	70
10003-13.....	58	10064-14.....	101	10315-12.....	56	11012-18.....	91	11063-07.....	76	11231-20.....	68
10004-13.....	57	10065-15.....	100	10316-14.....	56	11012-21.....	91	11064-07.....	79	11231-30.....	68
10006-12.....	61	10066-15.....	100	10317-14.....	56	11012-25.....	91	11065-07.....	79	11241-30.....	70
10007-12.....	59	10073-14.....	50	10318-14.....	56	11013-18.....	91	11066-07.....	79	11242-40.....	70
10007-16.....	59	10075-16.....	49	10321-08.....	108	11013-21.....	91	11067-07.....	79	11251-10.....	65
10008-13.....	57	10080-05.....	49	10360-13.....	108	11014-18.....	90	11069-08.....	79	11251-20.....	65
10010-00.....	58	10081-10.....	49	10370-13.....	51	11015-18.....	90	11070-08.....	79	11251-21.....	66
10010-10.....	61	10082-15.....	49	10370-17.....	108	11016-17.....	91	11071-10.....	81	11251-23.....	65
10011-00.....	58	10083-20.....	49	10370-18.....	108	11017-17.....	91	11072-11.....	83	11251-30.....	65
10011-10.....	61	10087-12.....	104	10370-19.....	108	11018-12.....	84	11073-10.....	82	11251-33.....	67
10012-00.....	58	10088-15.....	103	11000-12.....	87	11019-12.....	84	11074-02.....	82	11251-35.....	67
10015-00.....	58	10089-11.....	104	11000-13.....	87	11020-12.....	84	11075-00.....	82	11252-00.....	63
10015-10.....	61	10090-13.....	103	11000-14.....	87	11021-12.....	88	11080-02.....	90	11252-20.....	65
10020-00.....	57	10090-17.....	103	11000-16.....	87	11021-14.....	88	11083-07.....	76	11252-21.....	66
10021-00.....	57	10091-12.....	104	11000-18.....	87	11021-15.....	88	11084-07.....	76	11252-23.....	65
10022-00.....	57	10092-12.....	104	11000-20.....	87	11022-12.....	84	11090-09.....	76	11252-30.....	65
10023-00.....	57	10093-13.....	104	11000-25.....	87	11022-14.....	88	11091-15.....	97	11252-40.....	65
10025-45.....	52	10094-13.....	104	11000-30.....	87	11022-15.....	88	11092-12.....	97	11252-50.....	63
10025-50.....	52	10095-12.....	49	11001-12.....	87	11023-10.....	88	11095-09.....	96	11253-10.....	66
10030-13.....	100	10096-16.....	49	11001-13.....	87	11023-12.....	88	11095-13.....	96	11253-20.....	64

11253-21 64	11617-12 85	12060-01 110	14001-1329	14024-14 33	14085-0815
11253-25 64	11626-1167	12060-02 110	14001-1429	14028-1022	14085-0915
11253-2767	11627-12 85	12061-01 110	14001-1629	14029-1022	14086-0927
11253-29 64	11650-10 80	12061-02 110	14001-1829	14037-1028	14088-1018
11254-20 63	11651-10 80	12075-12 110	14002-1229	14040-1019	14090-0916
11255-20 65	11652-10 80	12075-14 110	14002-1329	14041-1019	14090-1116
11260-20 68	11700-0082	12076-12 110	14002-1429	14054-13 30	14091-0916
11270-20 69	11700-0182	12102-12 113	14002-1629	14058-0920	14091-1116
11271-30 69	11700-0282	12500-12 112	14003-1229	14058-1120	14094-1116
11272-30 69	11700-0382	12501-13 112	14003-1329	14059-0920	14095-1116
11272-40 69	11700-0482	12502-12 113	14003-1429	14059-1120	14101-1431
11272-50 69	11900-1478	12502-14 113	14003-1629	14060-0917	14105-1225
11273-20 64	12001-13112	12503-15 114	14003-1829	14060-1017	14106-0928
11273-22 64	12002-12113	12504-15 114	14003-2029	14060-1117	14108-0928
11274-20 69	12002-14113	12505-15 115	14004-1229	14061-0917	14110-1534
11280-11139	12003-15114	12510-14 111	14004-1329	14061-1017	14110-1734
11281-11139	12004-16114	12512-12 113	14004-1429	14061-1117	14111-1534
11282-11139	12004-18114	12565-14 111	14004-1629	14062-0917	14111-1734
11293-00 68	12005-15115	13002-10 96	14004-1829	14062-1017	14116-1433
11294-0070	12010-14111	13003-10 96	14005-1229	14063-0917	14116-1833
11295-00 65	12018-12119	13004-14 94	14005-1329	14063-1117	14117-1433
11295-10 65	12020-00121	13005-14 94	14005-1429	14064-1124	14117-1833
11295-20 63	12020-09121	13006-1292	14005-1629	14065-1124	14130-1730
11295-51 65	12022-09121	13007-1292	14007-14 30	14066-1124	14131-1431
11297-00 69	12023-00121	13008-1293	14008-1429	14067-1124	14160-1017
11297-10 69	12028-12119	13009-1293	14010-15 34	14068-1219	14161-1017
11370-31 74	12029-12119	13010-1293	14010-17 34	14069-1219	14171-1028
11370-3274	12030-01120	13011-1293	14011-1534	14070-1219	14173-1225
11370-4074	12030-04120	13012-1293	14011-1734	14071-1219	14184-0915
11370-4274	12030-20120	13013-1495	14012-1535	14072-1027	14185-0915
11373-1274	12030-22120	13014-1495	14012-1735	14074-0923	14200-2135
11373-2274	12030-23120	13015-1495	14013-1535	14074-1123	14370-2218
11399-8074	12035-00120	13018-1494	14013-1735	14075-0923	14370-2318
11399-8774	12040-01119	13019-1494	14014-1735	14075-1123	14501-1430
11412-1173	12040-02119	13020-1292	14015-1735	14076-0926	14502-1430
11413-1173	12040-03119	13021-1292	14016-1433	14077-0924	14504-1430
11445-1273	12050-01117	13108-1293	14016-1833	14077-1024	14505-1430
11480-1173	12050-02117	13109-1293	14017-1433	14078-1022	14508-1532
11485-1173	12050-03117	14000-1229	14017-1833	14079-1022	14509-1532
11487-1173	12050-10117	14000-1329	14018-1332	14080-1127	14510-1534
11506-1284	12050-20117	14000-1429	14018-1432	14081-0926	14510-1734
11602-1486	12051-08116	14000-1629	14018-1832	14082-0926	14511-1534
11602-1690	12051-09116	14000-1829	14019-1332	14083-0815	14511-1734
11608-1586	12051-10116	14000-2029	14019-1432	14084-0815	14512-1534
11616-1585	12051-11116	14001-1229	14019-1832	14084-0915	14512-1734

INDEX

14518-1432	15017-1010	16005-16..... 39	17005-04124	18020-40117	18055-05132
14518-1832	15018-104	16015-17 36	17006-05126	18020-50117	18055-06132
14519-1432	15019-104	16016-17 36	17007-08.....126	18020-60117	18056-14.....132
14519-1832	15020-15.....6	16020-14..... 36	17008-07125	18020-70.....117	18057-14132
14531-0931	15021-156	16021-14 36	17009-07125	18025-10.....77	18060-20141
14558-09.....21	15023-10.....8	16022-15.....37	17009-08125	18026-10.....77	18061-10141
14558-1121	15024-10.....8	16023-15.....37	17010-07.....125	18030-30117	18061-15141
14559-09.....21	15025-10.....8	16025-14.....47	17011-10.....127	18030-40117	18061-18141
14559-1121	15027-1812	16030-12.....44	17012-11128	18030-50117	18061-20141
14568-09.....20	15028-18.....12	16030-16.....44	17012-13.....128	18030-60117	18061-22141
14568-12.....20	15030-14.....13	16044-10.....44	17017-10.....127	18030-70.....117	18061-24141
14569-09.....20	15031-1413	16050-15.....45	17018-11128	18030-80117	18061-38141
14569-12.....20	15032-0814	16060-11.....41	17020-17122	18035-01159	18061-50141
14574-0923	15032-13.....14	16101-1042	17021-13122	18035-02159	18061-75.....141
14574-1123	15033-09.....8	16102-1142	17022-13122	18035-03159	18062-12135
14575-0923	15036-14.....13	16104-1446	17023-13122	18035-05159	18062-13135
14575-1123	15037-1413	16104-1946	17370-53124	18035-35159	18063-13135
14958-09.....21	15040-119	16105-1646	18000-00158	18035-50159	18064-20141
14958-1121	15042-119	16106-1446	18000-01158	18035-80159	18065-20141
14959-09.....21	15070-084	16107-1440	18000-02158	18036-19.....159	18067-1199
14959-1121	15071-08.....4	16109-1440	18000-03158	18036-22159	18080-01134
15000-00.....3	15110-08.....11	16120-1436	18000-04158	18036-24159	18080-02134
15000-015	15111-0811	16121-14.....36	18000-10.....138	18038-45133	18080-03134
15000-025	15123-126	16130-1545	18000-15.....144	18039-45133	18090-00156
15000-03.....3	15124-12.....6	16140-1143	18000-18.....157	18040-00.....134	18105-01159
15000-04.....3	15300-00.....14	16141-1143	18000-20157	18040-11130	18105-03159
15000-08.....3	15370-507	16142-11.....43	18000-30150	18040-14.....131	18131-12136
15000-10.....3	15370-527	16143-1243	18000-35163	18040-22130	18132-12136
15000-115	15371-92.....12	16144-1343	18000-45149	18040-33130	18133-12136
15000-12.....5	15396-00.....5	16150-24.....47	18000-46149	18050-28133	18144-30133
15001-083	15396-015	16152-11.....44	18000-50149	18050-35133	18155-1381
15002-083	15400-12.....6	16152-1244	18000-51149	18050-50133	18200-01129
15003-08.....4	15401-126	16152-1544	18004-18.....157	18051-28133	18200-02129
15004-08.....4	15514-129	16220-14.....36	18004-23157	18051-35.....133	18200-03129
15005-08.....4	15610-085	16221-1436	18004-27157	18051-50.....133	18200-04129
15006-09.....8	15615-085	17000-01123	18004-50157	18052-01133	18200-05129
15007-084	15617-08.....5	17000-02123	18010-00158	18052-02133	18200-06129
15008-08.....4	15650-1110	17000-03123	18010-01.....158	18052-03133	18200-07129
15009-08.....7	15651-1110	17000-04123	18010-02158	18052-12135	18200-08129
15010-0911	15750-117	17001-07126	18020-00117	18053-28133	18200-09129
15010-1011	15751-11.....7	17002-02123	18020-01117	18054-28133	18200-10129
15011-12.....9	16000-14.....38	17003-03123	18020-02117	18055-01132	18200-11129
15012-129	16001-1539	17004-03123	18020-03117	18055-02132	18200-12129
15013-129	16002-18.....37	17004-05124	18020-20117	18055-03132	18200-20129
15015-1110	16004-16.....39	17005-03123	18020-30117	18055-04132	18200-50129

18320-11.....133	20840-01.....153	26007-05.....107	29060-04.....147	91401-12.....173
18374-43.....133	20840-02.....153	26016-12.....106	29060-05.....147	91401-14.....173
18374-44.....133	20840-03.....153	26018-17.....106	29060-06.....147	91402-10.....173
18403-11.....139	20842-03.....153	26029-10.....83	29066-00.....147	91402-12.....173
18406-11.....139	20850-00.....153	26030-10.....83	29066-01.....147	91402-14.....173
18406-13.....139	20850-10.....153	26100-00...48,106	29066-02.....147	91413-14.....174
18555-01.....132	20890-51.....153	27000-01.....165	29066-03.....147	91460-11.....173
18555-02.....132	20890-72.....153	28000-07.....148	29066-04.....147	91461-11.....173
18555-03.....132	23005-10.....118	28000-10.....148	29071-01.....146	91500-09.....173
18555-04.....132	24201-00.....143	28000-12.....148	29071-02.....146	91501-09.....173
18601-15.....137	24201-01.....143	28001-00.....150	29071-03.....146	91604-09.....174
18602-15.....137	24212-01.....142	28001-02.....150	29071-04.....146	91606-07.....179
18603-14.....137	24212-02.....142	28015-15.....152	29071-05.....146	91706-05.....179
19003-00.....165	24214-02.....142	28015-25.....171	29071-06.....146	91815-11.....175
19003-01.....165	24215-02.....142	28020-20.....152	29071-07.....146	
19007-05.....157	24220-00.....143	28020-28.....171	29071-08.....146	
19007-07.....157	24220-10.....143	28030-02.....166	29080-00.....146	
19007-09.....157	24220-50.....143	28030-03.....166	30051-10.....161	
19007-14.....157	26000-25.....107	28030-04.....166	30076-14.....160	
19007-21.....157	26000-30.....107	28030-10.....166	30085-15.....162	
19007-29.....157	26000-35.....107	28030-20.....169	30085-30.....162	
19008-07.....157	26000-40.....107	28030-25.....169	30087-00.....163	
19008-09.....157	26000-45.....107	28040-30.....168	30087-20.....163	
19008-14.....157	26000-50.....107	28050-30.....168	30090-06.....160	
19009-00.....48	26000-55.....107	28050-35.....168	37000-00.....161	
19009-05.....157	26000-60.....107	28080-00.....167	37500-00.....161	
19009-07.....157	26000-65.....107	28080-90.....168	91003-12.....179	
19009-09.....157	26000-70.....107	29000-00...72,145	91100-12.....175	
19010-00.....48	26001-25.....107	29000-10..145,170	91100-16.....175	
19010-10.....48	26001-30.....107	29008-01.....144	91106-12.....175	
20020-00.....154	26001-35.....107	29008-12.....144	91110-10.....177	
20311-21.....154	26001-40.....107	29008-22.....145	91113-10.....177	
20325-00.....151	26001-45.....107	29015-50..145,170	91115-10.....177	
20325-10.....151	26001-50.....107	29025-01.....164	91117-10.....177	
20350-00.....151	26001-55.....107	29025-02.....164	91121-12.....175	
20810-01.....152	26001-60.....107	29026-00.....164	91127-12.....175	
20810-02.....152	26001-65.....107	29026-10.....164	91150-20.....176	
20820-00.....152	26001-70.....107	29027-00.....162	91197-00.....176	
20830-00.....155	26002-10.....107	29051-45.....144	91201-13.....178	
20830-01.....155	26002-15.....107	29055-00.....144	91308-12.....178	
20830-02.....155	26002-20.....107	29055-12.....144	91309-12.....178	
20830-03.....155	26007-01.....107	29060-00.....147	91400-10.....173	
20830-04.....155	26007-02.....107	29060-01.....147	91400-12.....173	
20830-05.....155	26007-03.....107	29060-02.....147	91400-14.....173	
20830-06.....155	26007-04.....107	29060-03.....147	91401-10.....173	

Alphabetical Index

A

Absorption Spears and Triangles	159
<i>Adson</i> forceps.....	84-85
<i>Adson</i>	84
<i>Adson-Brown</i>	85
<i>Adson DeBakey</i>	85
<i>Adson-Graefe</i>	85
Micro <i>Adson</i>	84
Micro <i>Adson</i> Fenestrated.....	84
<i>Agricola</i> retractor	124
<i>Allis</i> hemostatic forceps	97
<i>Alm</i> retractors.....	125
Applicators	
Micro serrefine	130-132
Suture clips	119-121
Applying forceps, clamp.....	131-132
Arc blade.....	56
Arteriotomy knives	50-53
Artery scissors	27
<i>Austin</i> Chisel	49
AutoClip® System	121

B

<i>Baby-Beyer</i>	37
<i>Baby-Mixter</i> hemostatic forceps	95
<i>Backhaus</i> towel forceps.....	96
Balanced Instruments	137
Ball Tipped	
Scissors	27
Spring Scissors	8
<i>Beebee</i> bone scissors	44
<i>Beyer</i> rongeurs.....	37
<i>Biemer</i> spring scissors	14
<i>Bishop-Harman</i> forceps.....	79
<i>Bonn-Strabismus</i> scissors	15
Blade	
Breakers	55
Cartridges.....	61
Holders	52-61
Blades	
Breakable	55
Ceramic	52
Scalpel.....	52-61
<i>Blair</i> retractor	122

<i>Boehler</i> bone cutter.....	45
Bone	
Cutters.....	40-47
Delicate scraper.....	49
Forceps.....	41
Nipper.....	42
Pliers.....	47
Rongeurs	36-39
Scissors	44
Scissors, Student.....	174
Scraper.....	49
Screw forceps	48
Screws, self-tapping.....	48
Shears	47
Wax	48

Bone cutters

<i>Beebee</i>	44
Bone Trimmers	40
<i>Boehler</i>	45
Cartilage Cutter	40
<i>Cleveland</i>	46
Dumont carbon steel	41
Dumont epoxy coated.....	41
<i>Liston</i>	46
<i>Littauer</i>	44
Malleus Nipper.....	43
Offset Bone Nipper.....	42
Skull Flap	45
Spring Scissors	43
Tungsten Carbide	44
Bone Nipper.....	42

Bonn

Artery	27
Forceps.....	76
Micro probes	100
Scissors	15, 27
Strabismus	15
Book and DVD- <i>Suturing Principles</i>	118
<i>Bowman</i> retractor	126
Bulldog clamps	133
Burrs.....	157

C

Calipers	
<i>Castroviejo</i>	163
Digital electronic.....	163
Plastic Vernier	163
Cane blade.....	56

Cannulation aids.....	135-139
Cartilage Cutter.....	40
Cases, instrument	152-155
<i>Castroviejo</i>	
Caliper	163
Needle holders.....	110-111
Spring scissors.....	10
Cauterizers, vessel	158
CeramaCut, scissors.....	21
Ceramic	
About.....	183
Blades.....	52
Dumont forceps.....	63, 69
Scissors	21
Spring scissors.....	7
Titanium	10
Chisels	
<i>Austin</i>	49
Dissecting.....	49
Circle forceps.....	83
Circle knife	51
Clamps	
Applying forceps.....	131-132
Bulldog Artery Spring Clamps	133
Bulldog Type Serrefines.....	133
<i>Dietrich</i> Bulldog Clamps.....	133
Double Micro Clamps.....	130
Mini Serrefines	133
Moria	133
S&T	130
<i>Schwartz</i> Micro Serrefines.....	133
Silver Neuro Clips	134
Titanium	132
Vascular.....	130, 132-133
Vascular Occluders	134
<i>Cleveland</i> bone cutters	46
Clip-On LED Light.....	169
Clipper style scissors	14
<i>Cohan-Vannas</i> spring scissors	5
<i>Colibri</i> retractor	123
<i>Colibri</i> retractor (mini)	123
Combination Probe and Spatula	103
Combination Spoon and Spatula	103
Contacts, Gold wire.....	165
Corers, sample.....	159
Cover glass forceps.....	82
Cover slip forceps.....	67
<i>Crile</i> hemostatic forceps	94

- Crile-Wood* needle holders..... 114
Curettes, micro..... 49
- D**
- DeBakey* forceps..... 85
Decapitation scissors..... 35
Demagnetizer..... 144
Diamond knives..... 52
Dietrich bulldog clamps..... 133
Digital Electronic Caliper..... 163
Dilator, vessel..... 136-137
Disposable safety scalpels..... 60-61
Disposable scalpel box..... 59
Dissecting Chisel..... 49
Dissecting knives..... 50-51
Double-Ended Micro Spatula..... 104
Double Micro Clamps..... 130
Double pronged tissue pick..... 99
Double tip protectors..... 147
Dowell spring scissors..... 9
Dressing forceps..... 80, 86-87
Dumont
 Bone Cutter..... 41
 Ceramic..... 63, 69
 Coverslip..... 67
 Epoxy..... 70-71
 Forceps..... 41, 63-72, 139
 Forceps repair kit..... 72, 145
 Forceps sharpening stones..... 72, 145
 Laminectomy..... 70
 Mini Forceps..... 72
 Slide Lock..... 67
 Super Fine Tip..... 63
 Teflon..... 67
 Titanium..... 65, 69
 Tweezers..... 63-72, 139
Dura cutting knife..... 50
Dura hook..... 99
- E**
- Ear
 Punches..... 142
 Tags..... 143
 Tattoo system..... 143
Electronic timers..... 165
Etched micro needles..... 107
Eschenbach magnifiers..... 168-169, 171
- Extra Fine *Bonn*..... 15
Explorers..... 101
- F**
- Feeding needles..... 141
File set..... 160
Filters, sterilization containers..... 153
Fine
 Bonn..... 15
 Forceps..... 73-79
 Iris Scissors..... 16
 Scissors..... 15-28
 Spring scissors..... 3-14
Fine Hemostat..... 92
Fixation forceps, *Pierson*..... 81
Fomon retractor..... 122
Forceps
 Adson..... 84-85
 Adson-Brown..... 85
 Adson DeBakey..... 85
 Adson-Graefe..... 85
 Applying and removing..... 119
 Bishop-Harman..... 79
 Bone..... 41
 Bonn..... 76
 Cannulation..... 139
 Ceramic..... 63, 69
 Circle..... 83
 Cover glass..... 82
 Cover slip..... 67
 Cross action..... 82
 Dressing..... 80, 86-87
 Dumont..... 41, 63-72, 139
 Epoxy coated..... 41, 70-71
 Fine..... 73-79
 Fixation..... 81
 Gerald..... 90
 Gillies..... 89
 Graefe..... 80
 Grasping..... 78
 Hemostatic..... 92-97
 Insect handling..... 83
 Laminectomy..... 70
 London..... 90
 Micro..... 63-76
 Mirror Finish..... 65, 73, 76
 Moria..... 74
 Mouse laminectomy..... 70
- Mouse handling..... 87
Narrow Pattern..... 86
Octagon..... 79
Organ holding..... 89
O-rings..... 72
Pierson fixation..... 81
Pin & bone screw holding..... 48, 106
Plastic..... 82
Potts-Smith..... 91
Repair kit..... 72, 145
Ring..... 83
Russian..... 89
S&T..... 75, 77, 139
Self-Closing..... 73
Semken..... 86
Standard Forceps..... 81-91
Standard Pattern..... 87
Student..... 175-177
SuperGrip..... 75
Suture tying..... 76-77
Taylor..... 91
Titanium..... 65, 69, 80, 86, 90
Tungsten carbide..... 84
Vetro Grasping..... 78
Vial..... 78
Friedman rongeur..... 38
Friedman-Pearson rongeur..... 36
- G**
- Galilean Loupes..... 168
Gavage feeding needles..... 141
Gelpi retractor..... 127
GenoPunch..... 142
Gerald forceps..... 90
Gillies forceps..... 89
Gold wire contacts..... 165
Goldstein retractor..... 123
Graefe forceps..... 80
Graefe knife..... 50
Grasping forceps..... 78
Grease, silicone..... 144
Gross anatomy
 Knives..... 54
 Probe..... 103
 Scalpel..... 60
 Scissors..... 29-35
Guthrie retractor..... 122

H

Halsey needle holders 112
Halsted-Mosquito hemostatic forceps93
 Handles, scalpel 57-61
 Hardened Fine Iris Scissors..... 16
Hartman hemostatic forceps96
 Headband magnifier166
 Headband, spectacles.....168
Heiss retractor127
 Hemostatic forceps
 Allis Forceps97
 Baby-Mixer.....95
 Backhaus Towel Forceps96
 Crile.....94
 Fine92
 Halsted-Mosquito93
 Hartman.....96
 Kelly.....94
 Left-handed.....93
 Micro-Mosquito.....93
 Providence-Hospital95
 Smooth92
 Student.....178
 Ultra Fine.....92
 Hippocampal dissecting tools..... 105

Holders

Blade..... 52-61
 Ceramic blade52
 Micro needle 110
 Needle 110-115, 178
 Pin.....106, 179
 Scalpel blade..... 52-61

Hooks

Micro 101-102
 Spinal cord99
 Y-Hook102
 V-Hook135

Hot bead sterilizers 149

I

Identification, animal

Tattoo system143
 Ear punches.....142
 Ear tags143

Insect

Handling forceps83
 Pins107

Insert

Pin holders..... 106, 179
 Pins107

Instrument

Beaker.....156
 Cases..... 152-155
 Holding spring 156
 Oil and Oil Pen.....144
 Sharpening Stones..... 144-145
 Tape, identification146
 Tip protectors..... 147
 Iridectomy scissors.....3-14
 Iris Spatulae..... 104

K

Kaye scissors28
Kelly hemostatic forceps.....94

Knives

Circle.....51
 Diamond52
 Dura cutting50
 Gross anatomy (blade).....60
 Micro50-52
 Sichel.....50
 Stone age53
Von Graefe.....50

L

LaGrange scissors.....25
 Laminectomy forceps, mouse70
 Large Loops 19, 28, 31
 Left-handed
 Fine scissors..... 17
 Hemostatic forceps.....93
 Ligation aid.....135
 Needle holders..... 113-114
 Surgical scissors29
 Utility scissors..... 161
Lempert rongeur39
 Lens paper 145, 170
Lexer-Baby scissors22
 Ligation aid135
 Ligation scissors.....26
Lister scissors31
Liston gross anatomy cutter.....46
Littauer bone cutter44
 Live Insect Handling Forceps83
 Lubricant, silicone144
Luer rongeur39

M

Magnetic sterilization mat..... 151
 Magnifiers
 Eschenbach Clip-On LED Light 169
 Galilean Loupes.....168
 Headband168
 Interchangeable Headset with LED167
 Magnifying Loupe with Micrometer
 and LED164
 Spectacles166-169
 Stands171
 Scribolux.....171
 Vario Flex.....171
 Malleus Nipper43
 Mandrel.....157
 Manipler®, skin stapler120
 Manual and DVD, *Suturing Principles
 and Techniques in Laboratory Animals*..... 119
 Marker, skin150
 Mat, silicone153
Mathieu needle holder111
 Max Detail spectacles169
Mayo scissors.....34
Mayo-Hegar needle holder114
Mayo-Noble scissors.....35
Mayo-Stille scissors35
Metzenbaum scissors
 Baby scissors.....32
 Scissors33
 ToughCut *Metzenbaum*.....33
 Tungsten Carbide *Metzenbaum Fino*.....32
Michel suture clips119
 Micro-
 Cannulation System138
 Curettes.....49
 Dissecting knives50-52
 Dissection scissors3-14
 Forceps63-76
 Hooks.....101-102
 Needles, etched.....107
 Needle holders.....110
 Needles and sutures.....116-117
 Points.....100,102
 Probes.....100-102
 Rongeurs36
 Serrefine applicators131-132
 Serrefines.....130, 132

- Spatulae 102-104
 Micrometers 164
 Micro-Mosquito Hemostat 93
Mini-Biemer spring scissors 14
Mini-Colibri retractor..... 123
Mini-Lister..... 31
Mini-Vannas spring scissors 5
 Minutien pins..... 107
 Mirror finish
 Cutting spoon..... 108
 Forceps 65, 73
 Micro spatula 104
 Suture tying forceps 76
 Moria
 Forceps 74
 Instrument case 155
 Retractors..... 124
 Scissors 18
 Spoons..... 108
 Spring scissors..... 12
 Vascular clamps 133
 Mosquito hemostatic forceps..... 93
 Mouse
 Feeding needles..... 141
 Laminectomy forceps..... 70
 Handling forceps..... 87
- N**
 Narrow Pattern Forceps..... 86
 Needle Holders
 Castroviejo..... 110
 Castroviejo with Tungsten Carbide Jaws . 111
 Crile-Wood..... 114
 Halsey..... 112
 Halsey with Tungsten Carbide Jaws..... 112
 Mathieu 111
 Mayo-Hegar 114
 Needle Holder with Suture Cutter 110
 Olsen-Hegar with Suture Cutter 113
 Round Handled..... 110
 Ryder Mini-Select Needle Holder 115
 Slim Elongated Needle Holder 115
 Needles
 Etched, micro..... 107
 Feeding..... 141
 Micro needles and sutures 116
 Neuro punches..... 159
- Neuro clips, silver 134
Noyes spring scissors..... 9
 Nylon suture thread 117
- O**
 Obsidian scalpels..... 53
 Occluders, vascular 134
 Octagon Forceps..... 79
 Offset Bone Nipper 42
 Oil, instrument 144
 O-rings for forceps 72
Olsen-Hegar needle holders 113
 Optical cleaning kit..... 145, 170
 Organ holding forceps..... 83
- P**
Pascheff-Wolff spring scissors..... 12
Pearson rongeur..... 36
 Pen
 Oil..... 144
 Skin Marker 150
 Perforated Spoons..... 108
 Pick
 Double Pronged Pick 99
Pierse fixation forceps..... 81
 Pin holders 106
 Pins
 Etched Tungsten Micro Needles 107
 Insect..... 107
 Insert 107
 Minutien 107
 Plastic cases..... 152-155
 Plastic forceps 82
 Plastic sterilization container 152-153
 Plastic Vernier Caliper 163
Potts-Smith forceps 91
 Pouches, sterilization 148
 Probes
 Bonn Micro Probes..... 100
 Combination Probe and Spatula 103
 Gross Anatomy Probe 103
 Micro Hooks 101-102
 Micro Points 100, 102
 Probes and Explorers 101
 Vessel Dilating Probe..... 103
Providence-Hospital hemostatic forceps..... 95
- Punches
 Ear..... 142
 Neuro..... 157
- R**
 Repair kit, forceps 72, 145
 Retractors
 Agricola 124
 Alm Retractors 125
 Blade..... 123-125
 Blair..... 122
 Bowman..... 126
 Colibri..... 123
 Fine Adjustable Wire Retractor 124
 Fomon 122
 Heiss..... 127
 Gelpi 127
 Goldstein 123
 Guthrie 122
 Large..... 124-129
 Mini-Goldstein..... 123
 Mini-Colibri..... 123
 Moria 124
 Slide..... 123
 Small..... 122-123
 Speculum..... 124
 Spring-Loaded..... 126
 Student..... 179
 Systems..... 129
 Weitlaner-Locktite 128
 Wire..... 124
 Wullstein 128
 Ring forceps..... 83
 Rongeurs
 Baby-Beyer 37
 Beyer..... 37
 Bone..... 36-39
 Friedman..... 38
 Friedman-Pearson..... 36
 Lempert..... 39
 Luer..... 39
 Micro 36
 Pearson..... 36
 Round Handled
 Needle holder..... 110
 Spring scissors 6
 Suture tying forceps 77

INDEX

Rulers			
Label Tape	162		
Steel	162		
<i>Russian</i> forceps	89		
S			
S&T			
Cannulation forceps	139		
Forceps	75, 77, 131, 136, 139		
Instrument beaker	156		
Micro needles and suture	116		
SuperGrip forceps	75		
Suture tying forceps	77		
Vascular clamps	130		
Vessel dilator	136		
Safety scalpel			
Blade cartridges	61		
Disposable	60		
Handle	61		
Sample corers	159		
Saw, Circular	157		
Scalpel			
Blade handles	52-61		
Blade removers	59		
Blades	52-61		
Ceramic blades	52		
Disposal Box	59		
Disposal Safety	60		
Gross anatomy	60		
Safety Scalpels	60-61		
Stone age	53		
<i>Schwartz</i> micro serrefine	133		
Scissors			
Bone	44		
<i>Bonn</i>	15, 27		
<i>CeramaCut</i>	21		
Clipper	14		
Decapitation	35		
Dissector	26		
<i>Dowell</i>	9		
Fine	15-28		
<i>Kaye</i>	28		
<i>LaGrange</i>	25		
Large loops	19, 28, 31		
Left-handed	17, 29, 161		
<i>Lexer-Baby</i>	22		
Ligature	26		
<i>Lister</i>	31		
<i>Mayo</i>	34		
<i>Mayo-Noble</i>	35		
<i>Mayo-Stille</i>	35		
<i>Metzenbaum</i>	32-33		
<i>Mini-Lister</i>	31		
Moria	5, 7, 12, 18		
<i>Shea</i>	25		
<i>Spencer</i> Ligature	26		
Spring	3-14		
Standard Pattern	29		
<i>Stevens</i> Tenotomy	24		
<i>Strabismus</i>	23		
Student	173-174		
Student <i>Lister</i>	174		
Surgical	29-35		
Titanium	5		
ToughCut	6, 15, 20, 25, 30, 33-34		
ToughCut with tungsten carbide	21		
Tungsten carbide	9, 20, 21, 23, 30, 32, 34		
Utility	161		
Vitrectomy	13		
<i>Walton</i>	24		
Screwdrivers	160-161		
Screws, self-tapping bone	48		
Secure scalpel handle	58		
Self closing forceps	73		
Self Holding Pin and Bone Screw Forceps	48, 106		
Self-Sealing Sterilization Pouches	148		
<i>Semken</i> forceps	86		
Serrefines	132, 133		
Sharpening stones	144-145		
<i>Shea</i> scissors	25		
Shears, bone	47		
<i>Sichel</i> knife	50		
Silicone lubricant	144		
Silicone mats	151		
Silicone tips, forceps	87		
Silk sutures	117		
Skin marker	150		
Skin staplers	120-121		
Skull flap cutter	45		
Slide retractors	123		
Spatulae			
Combination Spoon and Spatula	103		
Combination Probe and Spatula	103		
Double-Ended Micro Spatula	104		
Hippocampal Dissecting Tool	105		
Iris Spatulae	104		
Micro Spatula	102, 104		
Mini Hippocampal Dissecting Tool	105		
Mirror Finish Micro Spatula	104		
Spears, absorption	159		
Spectacles Headband	168		
Spectacles, magnifier	166-169		
<i>Spencer</i> Ligature	26		
Spinal Cord Hook	99		
Spoons			
Mini Perforated Spoon	108		
Mirror Finish Cutting Spoon	108		
Moria Spoon	108		
Perforated Spoon	108		
Spring scissors			
Angled	3-5, 8-9, 11-13		
Ball Tipped	8		
<i>Biemer</i>	14		
Bone Cutter	44		
<i>Bonn</i>	15		
<i>Castroviejo</i>	10		
Ceramic coated	7		
Clipper Scissors II	14		
<i>Cohan-Vannas</i>	5		
<i>Dowell</i>	9		
Extra fine	3-5, 12-13		
Iridectomy	3-14		
<i>Mini-Vannas</i>	3		
Moria	5, 7, 12, 18		
<i>Noyes</i>	9		
<i>Pascheff-Wolff</i>	12		
Round Handled	6		
Serrated	4, 6		
Student <i>Vannas</i>	173		
Titanium <i>Vannas</i>	5		
ToughCut	6		
Trident II	11		
<i>Vannas</i>	3-7, 173		
<i>Vannas-Miniature</i>	5		
<i>Vannas-Tubingen</i>	4		
<i>Vannas-Wolff</i>	7		
Vessels	14		
Vitrectomy	13		
<i>Wescott</i>	10		
Spring, instrument holding	156		
Stage micrometers	164		
Standard Pattern Forceps	87		
Standard Pattern Scissors			
Large Loops	31		
Scissors	29-31		

Serrations.....31
 ToughCut30
 Tungsten Carbide30
 Staplers, skin..... 120-121
 Sterilizers, hot bead 149
 Sterilizing containers..... 152-153
 Sterilizing mats..... 151
 Sterilizing pouches 148
 Sterilizing wraps..... 152
Stevens tenotomy scissors 24
 Stone Age Scalpels53
Strabismus23
 Student
 Bone Scissors..... 174
 Dumont forceps..... 176
 Forceps 175-177
 Hemostatic forceps..... 178
 Instruments, About..... 183
 Lister..... 174
 Needle holder..... 178
 Pin holder..... 179
 Retractor 179
 Scalpel handle..... 179
 Scissors 173-174
 Spring scissors, *Vannas*..... 173
 SuperGrip forceps 75
 Surgical scissors..... 29-35
 Left-handed..... 29
 Surgery plate 129
 Suture
 Clips, AutoClip..... 121
 Clips, *Michel*..... 117
 Needles 116-117
 Nylon 117
 S&T micro needles and suture 116
 *Suturing Principles and Techniques in
 Laboratory Animals*, Manual and DVD... 118
 Thread 116-117
 Tying forceps..... 76-77

T

Tags, Ear..... 143
 Tape
 Dispenser 150
 Identification..... 146
 Sterilization 150
 Ruler Label 162
 Tattoo system..... 143
Taylor forceps91

Timers 165
 Tip protectors 147
 Tip Replacement.....87
 Tissue
 Pick99
 Scissors27
 Titanium
 About..... 183
 Artery clamp..... 133
 Ceramic 10
 Forceps 65, 69, 80, 86, 90
 Micro Point..... 102
 Micro Spatula..... 102
 Scissors5
 Serrefines..... 132
 Vascular Clamps..... 130, 132
 Y-Hook 102
 Tools 160-161
 ToughCut
 About..... 183
 Bonn-Strabismus 15
 Mayo..... 34
 Metzenbaum..... 33
 Scissors 6, 15, 20, 30, 33-34
 Spring scissors..... 6
 Scissors with tungsten carbide..... 21
 Standard Pattern..... 30
 Trepines 157
 Trident II spring scissors 11
 Tungsten needles, etched 107
 Tungsten carbide
 About 183
 Burrs 157
 Forceps 84
 Mayo..... 34
 Metzenbaum Fino..... 32
 Needle holders..... 111-115
 Noyes..... 9
 Scissors 9, 20-21, 23, 30-32, 34, 44
 Scissors with ToughCut 21
 Standard Pattern..... 30
 Strabismus..... 23
 Tweezers, Dumont..... 41, 63-72, 139

U

Ultra Fine Clipper Scissors II..... 14
 Ultra Fine Hemostat..... 92
 Utility scissors 161

V

Vannas spring scissors 3-7, 173
Vannas-Miniature spring scissors..... 5
Vannas-Tubingen spring scissors..... 4
Vannas-Wolff spring scissors 7
 Vascular clamps..... 130, 132-133
 Vascular occluders 134
 Vernier caliper..... 163
 Vessel cannulation aids 136-139
 Vessel cauterizer 158
 Vessel dilating probe..... 103
 Vessel dilators 103, 136-137
 Vessel spring scissors 14
 Vetro grasping forceps 78
 Vial forceps..... 78
 VisorLight..... 166
 Vitrectomy scissors 13
 V-Hook..... 135
Von Graefe knife 50

W

Wagner 19
Walton..... 24
 Wax 48
Weitlaner-Locktite retractor 128
Westcott spring scissors 10
 Wire contacts, gold..... 165
 Wire teeth retractor 125
 Wound Closure 110-121
 Wraps, sterilization 152
Wullstein retractor 128

Fine Science Tools Online

Helping you find and buy the right tools

Whether you contact us at our offices, through dealers, or online—our priority is customer service. As part of that service, we have a variety of features to help you research, quote, and purchase Fine Science Tools products at **finescience.com**. These features enhance and streamline your shopping experience by helping you:

- Quickly identify products by type and attributes with advanced search
- Get detailed specs and enlarged product views
- Use the extensive FAQs and pop-up glossary
- Save quotes and convert to orders online
- Pay with credit card or purchase order*
- View your online order history
- Track your shipments

*Payment by purchase order is available only for customers with a Net 30 account.

Our website is more engaging and informative than ever.



Zoom
Feature



High-Resolution
Images



Multi-Language
Support



Updated
Event Listings

We are continuously adding new products to our inventory.
Visit **finescience.com** to view all of our products.

FST products are not meant for use on humans.

Products offered by FST are sold with the understanding that they are used by qualified persons in veterinary, research and experimental procedures only. All of our European suppliers are ISO 9001 certified.

All FST surgical instruments are made from the finest German or Swedish stainless steel alloys (unless otherwise noted) and manufactured by skilled European craftsmen.

Most surgical instruments are shown actual size. As these instruments are handcrafted, dimensions may vary slightly from those stated in this catalog.

THE INFORMATION IN THIS CATALOG IS ACCURATE TO THE BEST OF OUR KNOWLEDGE. DESIGNS, STYLES AND DIMENSIONS DEPICTED IN THIS CATALOG ARE SUBJECT TO CHANGE WITHOUT NOTICE. ALL RECOMMENDATIONS OR SUGGESTIONS ARE MADE WITHOUT GUARANTEE, AND WE DISCLAIM ANY LIABILITY INCURRED IN CONNECTION WITH ANY RECOMMENDATION. WITH THE PURCHASE OF ANY PRODUCT FROM THIS CATALOG THE USER ASSUMES ALL RISKS AND LIABILITIES WHATSOEVER IN THE USE OF SUCH PRODUCTS. NEITHER SELLER NOR MANUFACTURER SHALL BE LIABLE IN TORT OR CONTRACT FOR ANY LOSS OR DAMAGE (DIRECT, INCIDENTAL, OR CONSEQUENTIAL) ARISING OUT OF THE USE, MISUSE, OR INABILITY TO USE SUCH PRODUCT.

FST IS A REGISTERED TRADEMARK OF FINE SCIENCE TOOLS INC. FINE SCIENCE TOOLS, TOUGH CUT, CERAMA CUT, AND FINE SURGICAL INSTRUMENTS FOR RESEARCH ARE TRADEMARKS OF FINE SCIENCE TOOLS INC. FST, TOUGH CUT, AND CERAMA CUT ARE REGISTERED TRADEMARKS OF FINE SCIENCE TOOLS (USA) INC. FINE SCIENCE TOOLS AND FINE SURGICAL INSTRUMENTS FOR RESEARCH ARE TRADEMARKS OF FINE SCIENCE TOOLS (USA) INC. FINE SCIENCE TOOLS AND FST ARE REGISTERED TRADEMARKS OF FINE SCIENCE TOOLS GMBH.

© COPYRIGHT 2019 THE TEXT, PHOTOS AND DRAWINGS CONTAINED IN THIS CATALOG ARE PROPRIETARY TO FINE SCIENCE TOOLS INC. AND MAY ONLY BE COPIED, DUPLICATED OR OTHERWISE REPRODUCED WITH THE WRITTEN CONSENT OF FINE SCIENCE TOOLS INC.